

contents



INTRODUCTION

Preface

- 3 intent & purpose
- 4 historic preservation ordinance
- 4 historic preservation commission

Historic Properties

- 5 historic resource surveys
- 5 national register district
- 6 downtown hawkinsville local historic district:
- 7 nr district and local historic district compared

Design Review Process

- 9 administration
- 10 applying for a Certificate of Appropriateness
- 11 frequently asked questions
- 12 preservation approaches

Historic Context

- 13 developmental history

Historic Character

- 15 commercial building form

contents

DESIGN GUIDELINES

Rehabilitation

- 19 roofs: forms, features, & materials
- 21 exterior materials
- 23 architectural details
- 25 commercial storefronts
- 27 windows: upper, side, & rear
- 29 doors & entrances
- 31 awnings & canopies
- 33 additions to historic buildings

Site

- 37 walls & fences
- 39 modern features
- 41 signs

New Construction

- 45 building placement & orientation
- 47 building scale & form
- 49 building materials & openings



APPENDIX

Secretary of the Interior's Standards

- 51 standards for rehabilitation

Glossary

- 53 glossary

Reference Works

- 57 books
- 58 preservation briefs



preface



This publication has been financed in part with federal funds from the National Park Service, U.S. Department of the Interior, through the Historic Preservation Division of the Georgia Department of Natural Resources. However, the contents and opinions do not necessarily reflect the views or policies of the Department of the Interior or the Georgia Department of Natural Resources, nor does the mention of trade names, commercial products or consultants constitute endorsement or recommendation by these agencies. This program received Federal financial assistance for identification and protection of historic properties. Under Title VI of the Civil Rights Act of 1964, Section 504 of the Rehabilitation Act of 1973, and the Age Discrimination Act of 1975, as amended, the U. S. Department of the Interior prohibits discrimination on the basis of race, color, national origin, age, gender or disability in its federally-assisted programs. If you believe you have been discriminated against in any program, activity, or facility as described above, or if you desire further information, please write to: Office for Equal Opportunity, National Park Service, 1849 C Street, N.W., Washington, D. C. 20240.

INTENT & PURPOSE

This booklet was initiated by the Hawkinsville Historic Preservation Commission and financed in part by the City of Hawkinsville on behalf of its current and future citizens. The purpose of this booklet is to provide information on local preservation measures, the design review process, and the visual character which defines Hawkinsville's Downtown Historic District. The remainder of the booklet outlines design guidelines for this historic commercial area. The guidelines listed and illustrated herein are designed to assist decision makers – property owners, developers, contractors, and commissioners – in developing design solutions which satisfy Hawkinsville's historic preservation ordinances.

HISTORIC PRESERVATION ORDINANCE

“In support and furtherance of its findings and determination that the historical, cultural and aesthetic heritage of Hawkinsville is among its most valued and important assets,” the City of Hawkinsville adopted a historic preservation ordinance in 1989. The ordinance is designed to preserve the community's identity and historic character, promote harmonious growth in relationship to historic properties, to strengthen community pride and awareness of historic assets, to stabilize property values and encourage investment in historic areas, to capture the benefits of tourism and economic development, and to maintain and protect historic properties. By preserving its unique historic character, the City ensures that future generations will enjoy the benefits of Hawkinsville's architectural heritage.

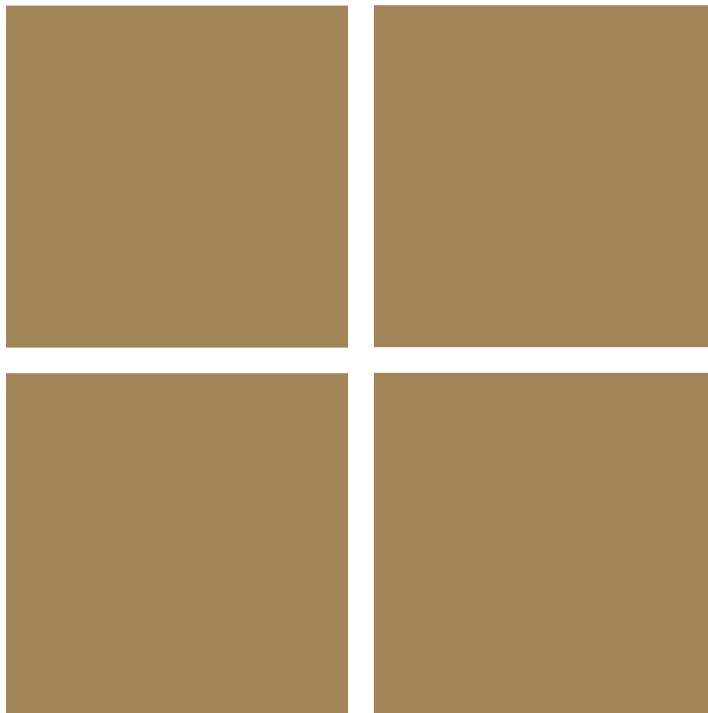

HISTORIC PRESERVATION COMMISSION

The Historic Preservation Ordinance establishes the Historic Preservation Commission (HPC), the volunteer board which serves as part of the planning functions of the City of Hawkinsville. The HPC is charged with the responsibility of initiating local designation, conducting the design review process, improving public education and awareness, securing preservation related grant funding, and supporting preservation planning and research. The Commission consists of seven appointed members, who serve three-year terms without monetary compensation. Because of the work of the HPC, the City of Hawkinsville also qualifies as a Certified Local Government (CLG) community. CLG status enables the municipality to apply for a variety of preservation grant and funding opportunities at the state and federal levels.



historic properties



HISTORIC RESOURCE SURVEYS

Historic resources in the City of Hawkinsville were surveyed in 1976 and 1990. The latter survey documented a substantial number of historic commercial buildings in downtown indicating eligibility for listing as a district in the National Register of Historic Places.

NATIONAL REGISTER HISTORIC DISTRICT

Downtown Hawkinsville became nationally recognized for its collection of architecturally and historically significant buildings when the *Hawkinsville Commercial and Industrial Historic District* was listed in the National Register of Historic Places (December 12, 2004).

The National Register is the nation's list of sites, places, structures, and districts of architectural, cultural, and historic significance. National Register status increases recognition for historic properties and enables property owners to participate in the federal and state tax incentive programs. However, little or no protection is afforded against demolition or insensitive alterations and/or additions.

historic properties

DOWNTOWN HAWKINSVILLE LOCAL HISTORIC DISTRICT

The National Register District boundaries served as a beginning point for exploring the designation of a local downtown district and full protection of the historic buildings located there. The Hawkinsville Historic Preservation Commission initiated a study of the area for the purposes of creating a local historic district. The study's recommendation was that a local historic district focused on the downtown, excluding the industrial area, would best match the community's goal. The Historic Preservation Commission held public hearing and forwarded this recommendation to the City Commission. The City Commission Designated the *Hawkinsville Downtown Historic District* December 3, 2007. The District is represented by the map below.

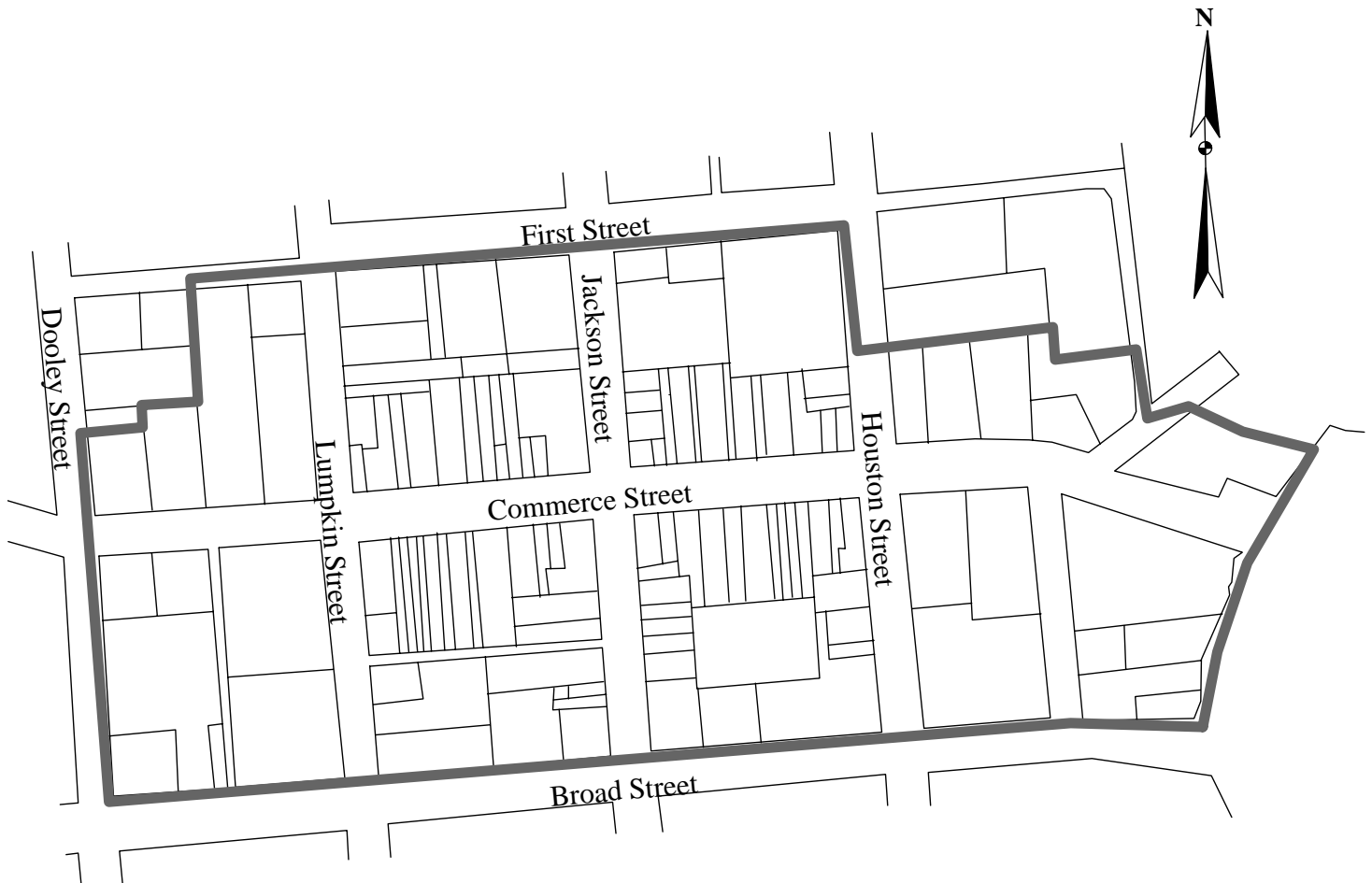
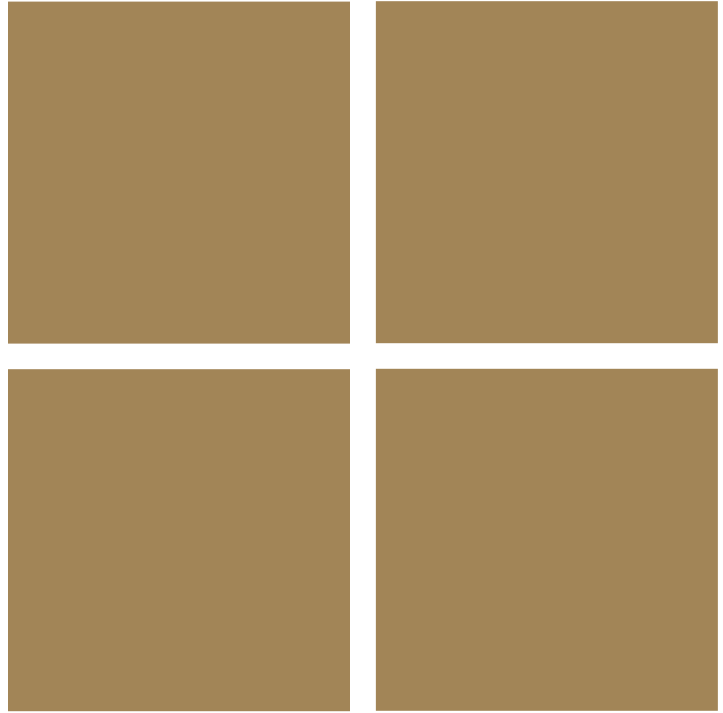

historic properties

NATIONAL REGISTER DISTRICT AND LOCAL HISTORIC DISTRICT COMPARED*

National Register District

A National Register historic district is a historic district that is listed in the National Register of Historic Places. The National Register is our country's official list of historic places worthy of preservation. It includes individual buildings, structures, sites, and objects as well as historic districts that are historically, architecturally, or archaeologically significant.

National Register listing recognizes the significance of properties and districts. By doing so, it identifies significant historic resources in a community. Boundaries of National Register districts are tightly drawn to encompass only concentrated areas of historic properties. Information compiled to nominate a historic district can be used in a variety of planning and development activities. National Register listing also makes available specific preservation incentives and provides a limited degree of protection from the effects of federally funded, licensed, or permitted activities.

The National Register is maintained by the U.S. Department of the Interior. In Georgia, the National Register program is administered by the Historic Preservation Division of the Department of Natural Resources. Districts and other properties are listed in the National Register through a 17-step process that involves identification, documentation, and evaluation. National Register historic districts most commonly encompass central business districts, residential neighborhoods, industrial areas, rural areas, and occasionally, entire communities.

Local Historic District

A local historic district is a district designated by a local ordinance, which falls under the jurisdiction of a local historic preservation review commission. A local historic district is generally "overlaid" on the existing zoning classifications in a community. Therefore, a local district commission deals only with the appearance of the district, not with the uses of those properties.

According to the 1980 Georgia Historic Preservation Act which makes such local designations possible, a local historic district is a "geographically definable area, urban or rural, which contains structures, sites, and/or works of art which have special historical or aesthetic interest or value; represent one or more periods or styles of architecture typical of one or more eras in the history of the municipality, county, state, or region; and cause that area to constitute a visibly perceptible section of the community."

The designation of a local district protects the significant properties and the historic character of the district. It provides communities with the means to make sure that growth, development, and change take place in ways that respect the important architectural, historical, and environmental characteristics within a district. Local designation encourages sensitive development in the district and discourages unsympathetic changes from occurring. This happens through a process called design review, whereby the historic preservation commission approves major changes that are planned for the district and issues Certificates of Appropriateness which allow the proposed changes to take place.

*excerpted from Georgia Historic Preservation Division's Fact Sheet "What's the Difference Between a National Register District and a Local Historic District?"

historic properties

NATIONAL REGISTER DISTRICT AND LOCAL HISTORIC DISTRICT COMPARED*

National Register District

Identifies significant properties and districts for general planning purposes

Analyzes and assesses the historic character and quality of the district

Designates historic areas based on uniform national criteria and procedures

Sets district boundaries tightly, based on the actual distribution pattern of intact historic properties in the area

Makes available specific federal and state tax incentives for preservation purposes

Provides a limited degree of protection from the effects of federally assisted undertakings

Qualifies property owners for federal and state grants for preservation purposes, when funds are available

Does not restrict the use or disposition of property or obligate private property owners in any way

Does not require conformance to design guidelines or preservation standards when property is rehabilitated unless specific preservation incentives (tax credits, grants) are involved

Does not affect state and local government activities

Does not prevent the demolition of historic buildings and structures within designated areas

Local Historic District

Protects a community's historic properties and areas through a design review process

Protects the historic character and quality of the district with specific design controls

Designates historic areas on the basis of local criteria and local procedures

Sets district boundaries based on the distribution pattern of historic resources plus other preservation and community planning considerations

Provides no tax incentives for preservation purposes unless such are provided by local tax law

Provides no additional protection from the effects of federally assisted undertakings

Does not qualify property owners for federal or state grants for preservation purposes

Does not restrict the use to which property is put in the district or require property owners to make improvements to their property

Requires local historic preservation commission review and approval, based on conformance to local design guidelines, before a building permit is issued for any "material changes" in appearance to the district

Does not affect federal, state, or local government activities

Provides for review of proposed demolitions within designated areas; may prevent or delay proposed demolitions for specific time periods to allow for preservation alternatives.

*excerpted from Georgia Historic Preservation Division's Fact Sheet "What's the Difference Between a National Register District and a Local Historic District?"

design review process



ADMINISTRATION

Property owners within the Hawkinsville Downtown Historic District enjoy the advantages of increased economic value and a built environment protected from unsympathetic changes. The Historic Preservation Commission (HPC) protects the rights and investments of property owners and business establishments through the design review process. By preserving and maintaining historic character, the HPC ensures that citizens and visitors alike will enjoy the benefits of Hawkinsville's historic built environment.

design review process

APPLYING FOR A CERTIFICATE OF APPROPRIATENESS (COA)

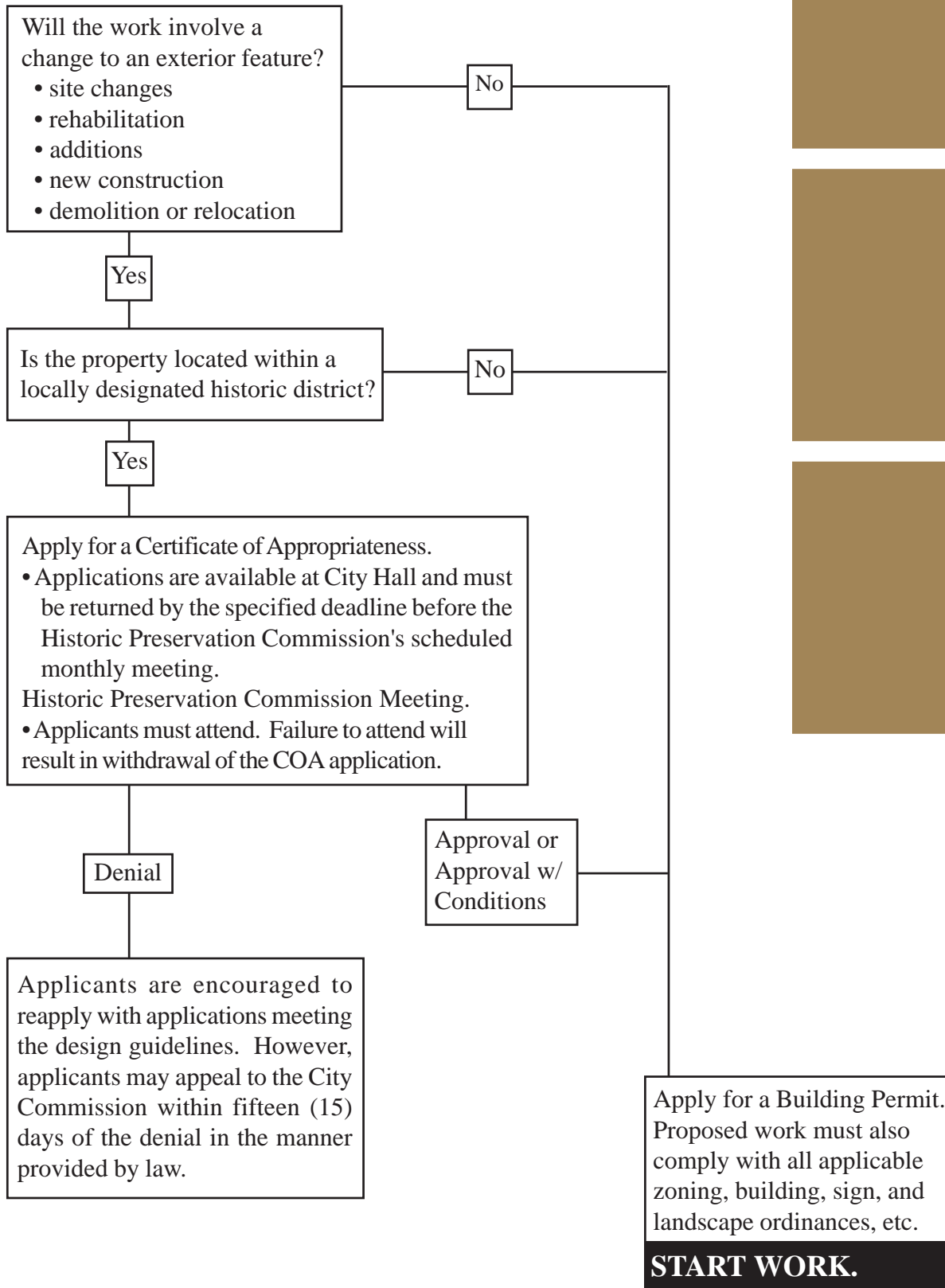

design review process

FREQUENTLY ASKED QUESTIONS

What is design review?

The Historic Preservation Ordinance provides for a design review process. Design review consists of the evaluation of any proposed exterior work upon a property within a locally designated historic district. Both minor and extensive projects must be reviewed and approved prior to beginning work. The design review process is often triggered by a building permit application; however, building permits can not be issued until design review is complete. Although some types of work projects, such as installation of a walkway or a fence, may not require a building permit, design review is still required.

Which properties require design review?

All locally designated properties require design review. Locally designated properties include all properties within locally designated historic districts and any locally designated individual properties. Please note that design review covers both historic and non-historic properties in a historic district. The city's Official Zoning Map shows all designated districts and properties. A call to the City Hall can confirm whether or not a property is locally designated.

What type of work requires design review?

All work involving a change to an exterior feature of a locally designated property requires design review. Projects that physically alter the property include but are not limited to: changes in site or setting; repair or rehabilitation; new construction or additions; and relocation or demolition.

Neither interior alterations nor a change in the use of the property require design review. The Historic Preservation Ordinance applies only to the external aspects of the property and regulates neither zoning nor land use. The HPC does not review planting or repainting. Ordinary maintenance does not require design review.

What is a Certificate of Appropriateness?

When planning a work project, an owner must submit a completed application for a Certificate of Appropriateness (COA). Applications are available from and should be returned to the city clerk. Monthly meetings of the Historic Preservation Commission (HPC) are advertised in the local newspaper. Public notice necessitates that applications to be submitted in advance of the meeting. Contact City Hall for deadlines.

Utilizing design guidelines and the general standards for the preservation of historic properties, the HPC must decide to approve or deny the application. If the application is approved, a Certificate of Appropriateness is issued and design review is complete.

What should an application include?

In order that the Commission may make an informed decision, completed applications must be accompanied by support materials. Illustrations may include site plans, elevations, and floor plans drawn to a standard architectural scale, e.g. 1/4" = 1'. Photographs of the building, site, and neighboring properties are also helpful. Support materials may differ according to the type and size of the project. The application and support materials must be submitted at the same time.

What could happen if work begins before design review?

If work is initiated prior to approval of a COA application or to obtaining a building permit, a stop work order may be issued. If these requirements are not met, the property owner may face fines and/or an order to restore the original condition of the property.

Are there any other review procedures?

Review of projects by the HPC may not be the only review required before work may proceed. Other city departments and commissions may be required to examine a project for compliance with existing zoning regulations, building codes, and sign or landscape ordinances.

design review process

PRESERVATION APPROACHES

The intent of Hawkinsville's Historic Preservation Ordinance is to protect the overall visual and historic character of the community's locally designated properties. Proposed projects within the historic districts can range from small site changes to new construction. Outlined below are some common types of projects and the general preservation approach to them.

Preservation

Preservation is defined as the act or process of applying measures necessary to sustain the existing form, integrity, and materials of an historic property. Work, including preliminary measures to protect and stabilize the property, generally focuses upon the ongoing maintenance and repair of historic materials and features rather than extensive replacement and new construction. As a general rule, a pure preservation project is limited to repair and would not require review from the HPC.

Rehabilitation

Rehabilitation is defined as the act or process of making possible a compatible use for a property through repair, alterations, and additions while preserving those portions or features which convey its historical, cultural, or architectural values. Review of such projects will focus on the how well the proposal achieves this goal.

New Construction

An important goal when building in a historic district or adding to a historic building is to fit the established visual character. However, new construction should not create a false history by merely copying historic precedents. While referencing an area's or building's existing elements, new construction should also be differentiated from historic examples. Historic examples should serve as a point of departure for compatible but creative design.

Existing Non-Historic Buildings

Changes to existing non-historic buildings should, at the very least, not cause the building to become more intrusive and, at best, increase the building's compatibility in the district. Such projects should follow the New Construction Guidelines.

Demolition

The demolition of historic buildings diminishes the built environment and creates unnecessary waste. Demolition of a historic structure is only approved in very rare, specific, and narrowly defined circumstances, and no demolition occurs without approval of post-demolition plans. The aspects the commission will take into consideration include but are not limited to: age, integrity, significance, condition, alternatives, and overall effect.

Relocation

Relocation falls into one of three categories: 1) removing a structure from a historic district, 2) moving a structure into a historic district, or 3) moving a structure to a different location within a historic district. Different criteria are applied to each. Proposed relocation out of a historic district constitutes a loss and therefore, demolition guidelines apply. New construction guidelines apply for proposed relocations into a historic district. For proposed relocations within a historic district, the following considerations apply: age, previous relocation, compatibility of the new site, significance, condition, alternatives, and overall effect.

Institutional Properties

Institutional properties, both public and private, are often the exception to the rule. While historic institutional properties, such as churches or government buildings, should follow the same guides for rehabilitation, new institutional buildings may vary from the surrounding district in some respects to distinguish the property's civic importance. For example, a new government building may utilize a deeper setback than surrounding historic buildings while using a similar exterior material.

historic context



DEVELOPMENTAL HISTORY

In 1808, Pulaski County was created from Laurens County and Hartford, a settlement the Ocmulgee River, selected as the county seat. The city of Hawkinsville was incorporated in 1830. The county seat was moved from Hartford to Hawkinsville in 1836 due to its emergence as an important river port for lower central Georgia. The original courthouse, built at Hartford in 1812, was moved to the courthouse square where it remained until construction of a new courthouse was begun in 1872, when it was moved across Commerce Street.

During the antebellum years, Hawkinsville grew steadily as a trade center and river port. Boat lines on the Ocmulgee River brought supplies up river from the coast at Darien. Cotton and other crops from the surrounding counties were carried down river by barge. By 1845 Hawkinsville had experienced modest but consistent growth, boasting six stores, two churches, two hotels, and a population of 175.

historic context

DEVELOPMENTAL HISTORY cont.



Hawkinsville developed into a major regional center for the processing, storage, and transportation of cotton following the end of the Civil War. The construction of the Macon and Brunswick Railroad through Hawkinsville in 1868 increased the town's accessibility to markets along the coast and the interior of the state. As a result, the town prospered and by the end of the 1870s the commercial section of the town extended along both sides of Commerce Street between Jackson and Houston Streets, and cotton sheds and warehouses lined the bluff.

In 1879 Hawkinsville experienced a devastating fire that nearly destroyed the entire business district. The town's businessmen began replacing the wood frame commercial buildings with brick buildings. By the 1890s, the commercial section along Commerce Street and North Jackson Street were well established. The late 1890s also saw the establishment of several utilities, including the construction of a city-owned light and water plant and the establishment of telephone service.

In 1902 a second railroad, the Oconee and Western, an extension of the Central of Georgia, was built through the city. As a result, the city's manufacturing base continued to grow and diversify, and the commercial section continued to prosper. Public buildings were also constructed such as Hawkinsville's City Hall and Auditorium in 1907, the Pulaski County Courthouse in 1910, and the Hawkinsville Fire House in 1917.

By the 1920s, the lumber industry had been firmly established as an important part of Hawkinsville's economy. Despite the devastating effects of the boll weevil on Georgia's cotton crop, Hawkinsville still had three substantial cotton processing and storage companies. Hawkinsville had a robust population of 3500 on the eve of the Great Depression.

As with other communities throughout Georgia and the nation, the 1930s were a difficult time for Hawkinsville when many shops and industries went out of business.

The 1940s saw the beginnings of the complex that eventually became the Heart of Georgia Peanut and Gin Company. The processing and storage of peanuts, pecans, and cotton remained principal industries in Hawkinsville throughout the 1950s, 1960s, and 1970s while the city's industrial base expanded. As a result, Hawkinsville's population continued to rise until the economic recessions of the 1980s. During the 1990s the community experienced population loss.



historic character



COMMERCIAL BUILDING FORM

The Downtown Historic District gains its distinct character from the similarity of the buildings located there. Commercial facades of differing styles, ages, and size use certain basic components in a coordinated manner to achieve a cohesive appearance. These basic components together create a store front at ground level and, for two story structures, an upper facade.

Whether one or two story, historic commercial buildings have a distinctive shape created by parapets and cornices. The parapet and building cornice serve to visually cap the building.

The upper facade is usually fairly solid in appearance pierced by windows at regularly spaced intervals. Ornament may surround the windows or divide the vertical bays.

The storefront is much more open in character compared to the relatively solid upper facade. This division between the ground floor and the upper stories scales the streetscape to a pedestrian level. The continuous line of display windows, often with awnings, create the feeling of an outdoor room.

historic character

COMMERCIAL BUILDING FORM

tops of buildings, known as the cornice, are often ornamented

roofs, usually a low slope shed or gable, are hidden behind a short wall known as a parapet

upper windows, usually double-hung sash placed symmetrically and regularly placed, may have decorative arches, hoods, or brickwork

transom windows

signboard area, traditional location for

cornice above storefront

display windows

bulkheads beneath the display windows; generally wooden

full or three quarter glazed doors, sometimes double doors



rehabilitation guidelines



DESIGN GUIDELINES

Rehabilitation

- 17 roofs: forms, features, & materials
- 19 exterior materials
- 21 architectural details
- 23 commercial storefronts
- 25 windows: upper, side, & rear
- 27 doors & entrances
- 29 awnings & canopies
- 31 additions to historic buildings



roofs: form, features, materials

DESIGN PRESERVATION

Roof design is integral in creating the overall shape or profile of a building. Downtown this is generally created by parapets which hide the main roof. Features such as finials, shaped parapets, and even chimneys enhance that silhouette. Visible historic roof forms and features should be preserved.



MATERIALS PRESERVATION

Roofing materials are periodically changed because, with a few exceptions, they have a limited lifespan. Flexibility is allowed for replacement materials, especially for those hidden by parapets. Conversely, visible, architecturally distinctive roofing materials are important to the character of the building.

GUIDELINES

- a. Maintain the existing pitch and shape of historic roofs as seen from the public view. Changes hidden by existing parapets may be considered.
- b. Replace existing historic roofing materials with the same type of roofing material. Changes in materials hidden by existing parapets may be considered.
- c. Retain historic secondary features and character defining materials.
- d. Maintain historic chimneys which contribute to the silhouette.
- e. Preserve historic skylights whenever possible.
- f. Replace incompatible, non-historic, roof designs with traditional parapet/low slope roofs.

roofs: form, features, materials

Specifics & Illustrated Examples

- a.1 Roof pitch or shape may be changed to improve drainage if hidden behind a parapet.
- a.2 A change in roof shape should not be visible.
- c.1 Significant roofing materials should be preserved and replaced in-kind when necessary.
- c.2 Decorative roof features should be preserved.
- d.1 Primary chimneys should be repaired or rebuilt, not removed.

☑ = satisfactory ☒ = unsatisfactory

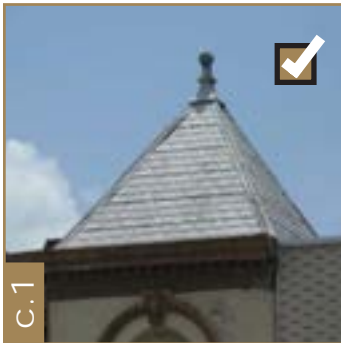
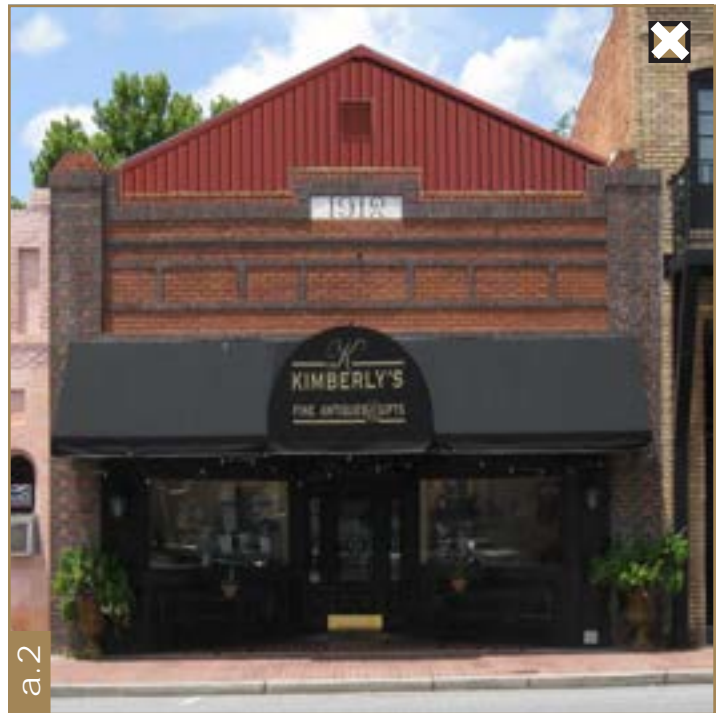
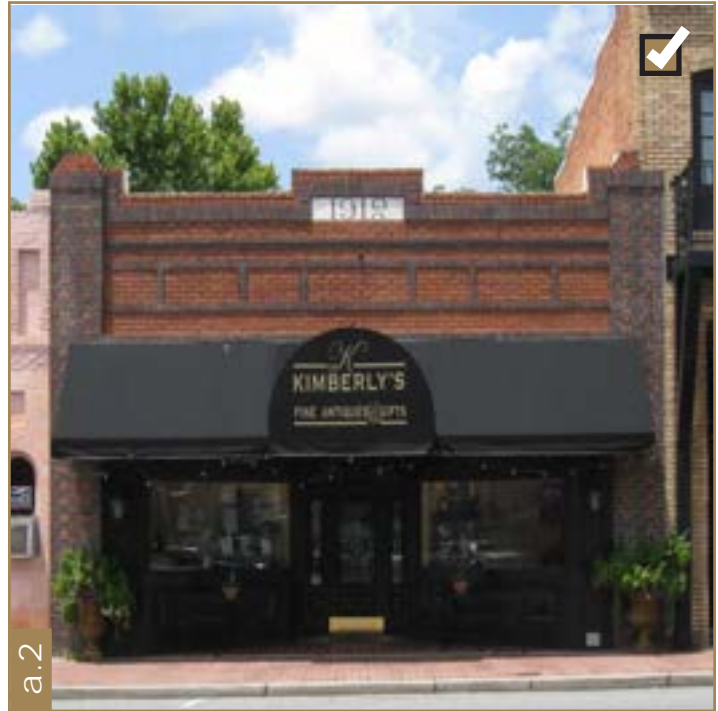

exterior materials

DESIGN PRESERVATION

Exterior materials affect design primarily through their texture. In order to preserve the character of a historic building it is important to preserve the texture - whether smooth, rough, uneven, or regular - of historic materials.



MATERIALS PRESERVATION

Preserving exterior materials hinges upon managing water and avoiding unintended damage during cleaning or repair. Some materials, such as wood, must be coated to repel water while others, such as brick, are meant to breath and can be damaged with coatings. Understanding an exterior material and the potential effects of a treatment is key in its preservation.

GUIDELINES

- a. Maintain and preserve historic materials.
- b. Leave unpainted historic masonry unpainted and uncoated.
- c. Repair damaged exterior materials in-kind and only in the area of damage, rather than total replacement.
- d. Use the same mortar mix, tooling, and mortar color as the historic masonry pointing when repointing brick on historic buildings. Use a qualified, professional mason.
- e. Use the gentlest means possible to clean exterior materials. Do not sandblast or use a wash with a pressure greater than 800 psi.

exterior materials

Specifics & Illustrated Examples

- a.1 Exterior materials should not be covered with other siding materials such as vinyl or synthetic stucco (E.I.F.S.).
- b.1 Painting historic brick or stone that has not previously been painted alters the original design and should not occur.
- b.2 Painting masonry can trap water inside the brick causing it to spawl.
- d.1 Improper pointing which doesn't match the historic mortar color and tooling negatively impacts the historic character of a building.
- d.2 Using a mortar with a higher Portland cement ratio (such as type S) can damage softer historic brick because it will not compress when the brick expands in response to climate.
- e.1 Sandblasting removes the fireskin of brick making it susceptible to erosion.

☑ = satisfactory ☒ = unsatisfactory

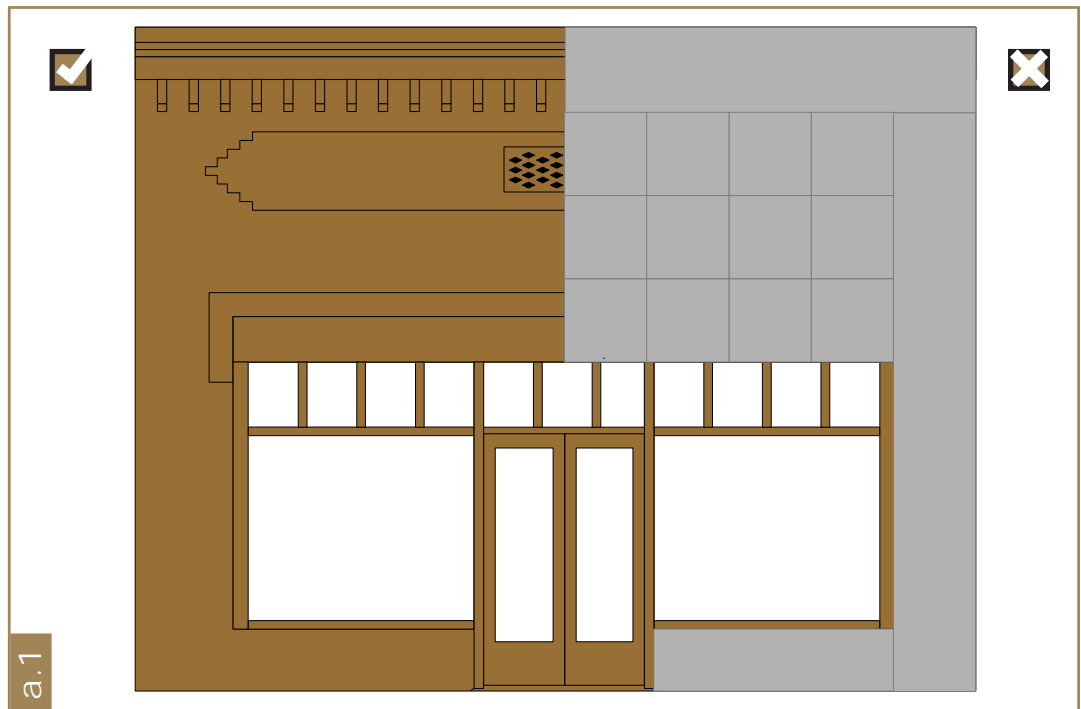

architectural details

DESIGN PRESERVATION

Details dress a building denoting a particular architectural style giving a visual clue to the structure's history. Consequently, the loss of details is a loss of history. Likewise, adding details creates false history.

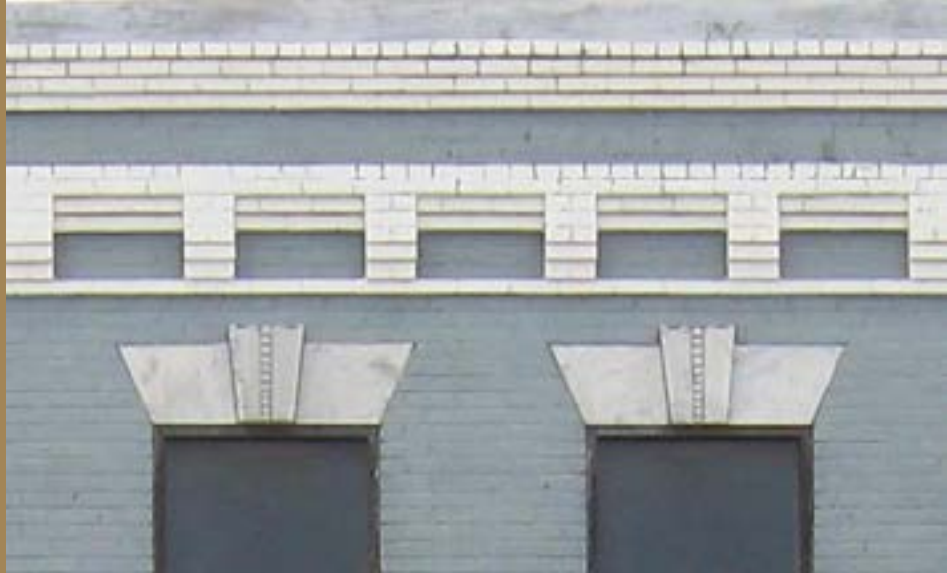

MATERIALS PRESERVATION

Architectural details are generally located in areas of high exposure - roof lines, corners, etc. - and may be particularly vulnerable to the elements. Periodically check condition and attachment.

GUIDELINES

- a. Maintain and preserve historic details.
- b. Replace damaged details with details of matching material and matching design.
- c. Restore missing details to historic buildings when documentation of those elements, such as historic photos, historic blueprints, or physical evidence, is available. Do not add details to historic buildings which were not known to have existed.

architectural details

Specifics & Illustrated Examples

- a.1 Removing architectural details, such as cornices, negatively impacts the character of a building.
- a.2 Unique materials such as terra cotta and decorative concrete block are especially significant.
- a.3 Maintain non-original details, such as Art Deco elements, that have gained historic significance.
- b.1 Replacing damaged details with “off the shelf” details which are not the correct scale detrimentally change the historic appearance of a building.
- c.1 Adding architectural details where none existed before creates a false sense of history.

☑ = satisfactory

☒ = unsatisfactory

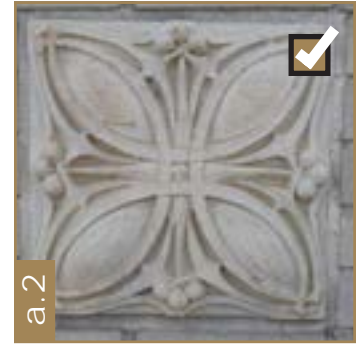
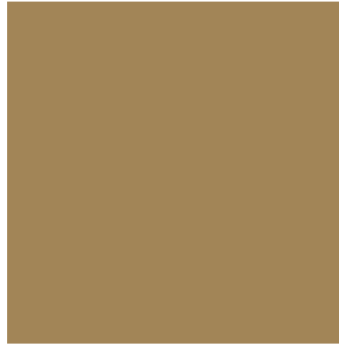

a.2

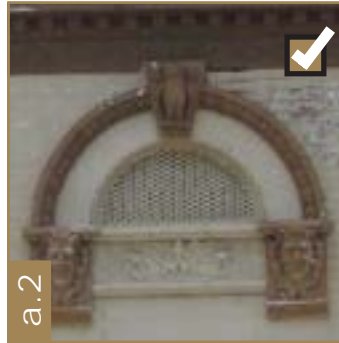

a.2



a.3



a.1

commercial storefronts

DESIGN PRESERVATION

The storefronts are designed to display merchandise and attract customers. Their design is typically open with large display windows, glazed doors, and a transom row above the windows. Maintaining this open design is imperative.



MATERIALS PRESERVATION

The wooden portions of storefronts - the window framing and the bulkheads beneath display windows - are the most vulnerable to deterioration. Keeping such elements painted and caulked is important. When damaged other materials should not be substituted for the wood.

GUIDELINES

- a. Maintain and preserve historic storefronts.
- b. Repair damaged portions rather than replacing them in total. If the historic storefront is too deteriorated to repair, the replacement should accurately replicate the original in design and materials.
- c. Maintain transoms. Reopening previously covered transoms is encouraged.
- d. Maintain the high ratio of window to wall in display area.
- e. Replacement of non-historic storefronts should be based on historical research and physical evidence. Where no documentation exists, use a new, simple, storefront design compatible with the size, scale, material, and color of the historic building. Aluminum may be used for framing the glass and should be anodized or powder coated, not raw aluminum.

commercial storefronts

Specifics & Illustrated Examples

- a.1 Replacing a storefront with smaller or more elaborate windows destroys the open character.
- a.2 Recessing a storefront to create outdoor dining creates more void than is appropriate for a historic building.
- a.3 Maintain the elements, materials, and design of historic storefronts such as cast iron columns, wooden bulkheads, and transoms.
- b.1 Replacing wooden bulkheads with brick changes the mass of the storefront and generally results in a loss of detail.
- b.2 Replacement glass should be clear not tinted or darkened. (Remember, building code may require safety glass in some locations.)
- c.1 Covering transom windows introduces a solid element that is not traditional to historic storefronts.

☑ = satisfactory ☒ = unsatisfactory

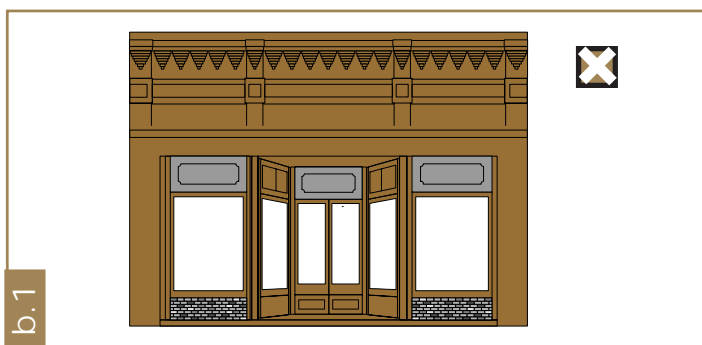
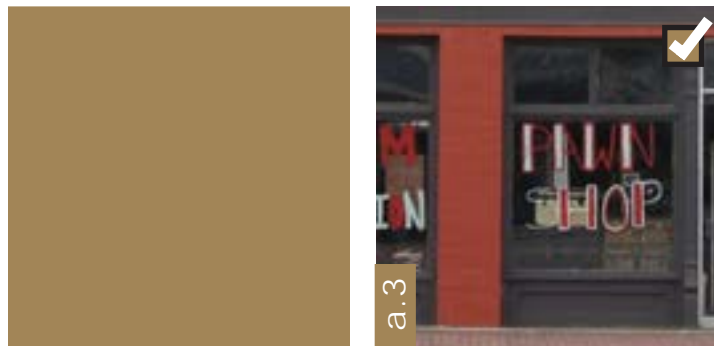
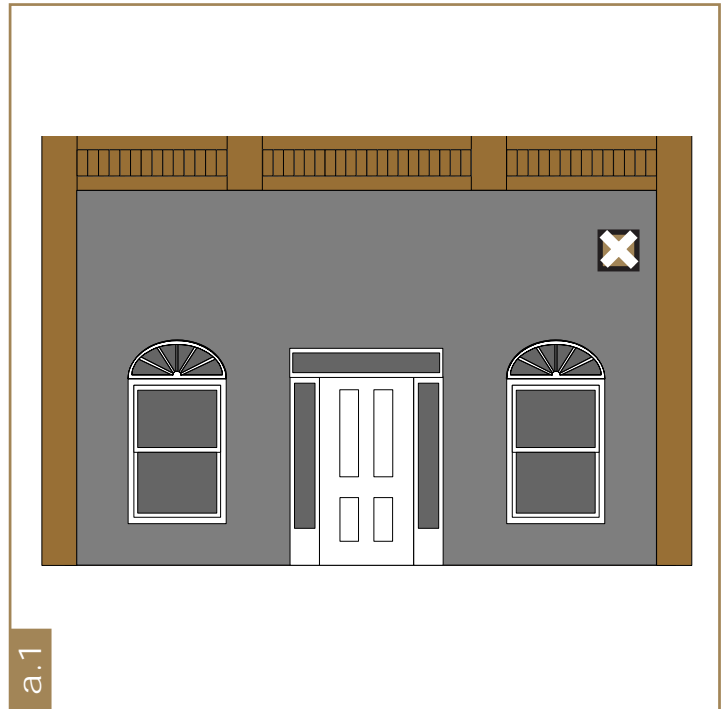

windows: upper, side, & rear

DESIGN PRESERVATION

Upper windows on the front of buildings were placed as part of the overall design, whereas side and rear windows related more to the interior use. The shape, pane configuration, and muntin design are part of the building's character. Maintaining window placement and design is important to the story of the building.



MATERIALS PRESERVATION

Historic wood windows will last indefinitely with proper maintenance. Made from first and second growth timber, their materials are of a quality unmatched by those found today. Periodic glazing, painting and caulking will keep them sound and airtight. Unlike most modern windows, damaged portions of historic windows can be replaced without resorting to replacing the entire window.

GUIDELINES

- a. Maintain and preserve historic windows.
- b. Repair damaged portions of historic windows rather than replacing them in total.
- c. Windows for reopened, historic window openings; for replacing later, non-historic windows in historic openings; or for replacing historic windows damaged beyond repair should be of matching design and matching (preferred) or nearly matching (may be considered) materials.
- d. Maintain the historic window opening placement and dimensions on the front of the building.
- e. New window openings may be considered on side and rear elevations provided they use traditional placement patterns.
- f. Windows for new openings should relate to historic windows in the following ways: a) use matching or similar materials; b) be of matching or similar size; and c) use similar but not matching design.
- g. Use exterior storm windows which match the color of the window frame and obscure the window as little as possible.

windows: upper, side, & rear

Specifics & Illustrated Examples

- a.1 Replace only the damaged portions of historic windows.
- c.1 Wood windows should be used for historic openings which historically contained wood windows, though clad with vinyl or aluminum may be considered.
- d.1 Replacing windows with a single sheet of glass, resizing, infilling, or using a different design (such as 60/40 sashes or no divided lights) on primary elevations is not appropriate.
- d.2 Adding new window openings on a building front should not occur.
- d.3 Infilling rear and side windows may be considered, especially for code required changes, provided the infill is recessed creating a blind window.
- e.1 Introducing new window openings on side elevations should not disrupt significant window placement patterns.
- f.1 Using Simulated Divided Light (SDL), double pane windows for new openings or to replace non-historic windows is allowable. Using grilles-between-the-glass is not.

☑ = satisfactory

☒ = unsatisfactory

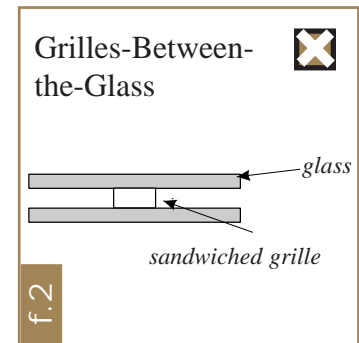
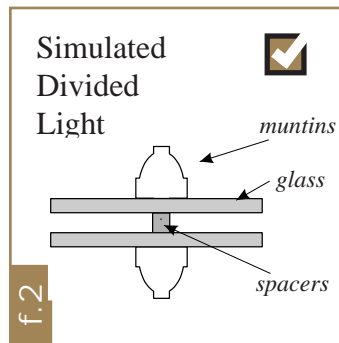
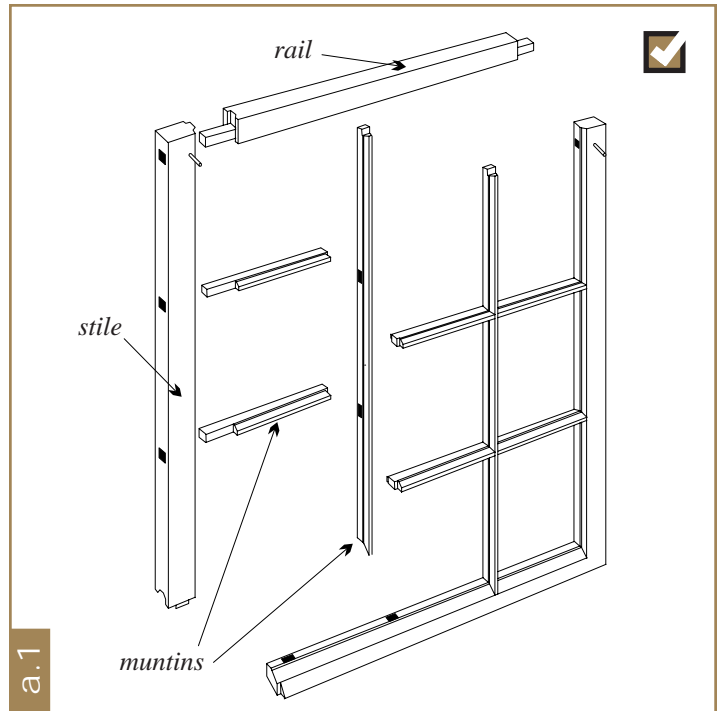

doors & entrances

DESIGN PRESERVATION

Entrances consist of doorways and their surrounding elements. Entrances on facades access the shop areas and stairs to upper stories. These configurations should remain intact despite changes in use. Rear elevations contain service entrances and may provide an area for flexibility in design change.



MATERIALS PRESERVATION

Like windows, historic doors are a composite of several components. Damaged components can be replaced while preserving the viable historic portions of the door. Regular maintenance of a wooden door will keep it in working order.

GUIDELINES

- a. Maintain and preserve historic doors and surrounding features.
- b. Repair damaged portions of historic doors rather than replacing them in total.
- c. Doors for reopened, historic door openings; for replacing later, non-historic doors in historic openings; or for replacing historic doors damaged beyond repair should be of matching design and materials.
- d. Maintain the historic door placement on the fronts and sides, including entrances to upper floors. Reopening infilled historic doorways is encouraged.
- e. New door openings may be considered on side and rear elevations provided they utilize traditional placement patterns and designs.
- f. Doors for newly created doorways,; a) use matching or nearly matching materials, b) be of matching or similar size, and c) use similar but not matching design.

doors & entrances

Specifics & Illustrated Examples

- d.1 Historic entrances on front elevations should not be infilled even if no longer used.
- d.2 Restoration of doorways and doors should be based on historical research and physical evidence. Where no documentation exists, use a new, simple design compatible with the building.
- e.2 Reduce loss of historic wall material by using an existing window opening for the location of a new door opening.
- f.1 Residential doors are out of place in the historic commercial setting and should be avoided.
- f.2 Generally, front doors in downtown have large areas of glass.
- f.3 Elaborate surrounds are not typical downtown.
- f.4 Metal doors may be considered on rear elevations when creating a new doorway or when replacing a non-historic door.

☑ = satisfactory ☒ = unsatisfactory

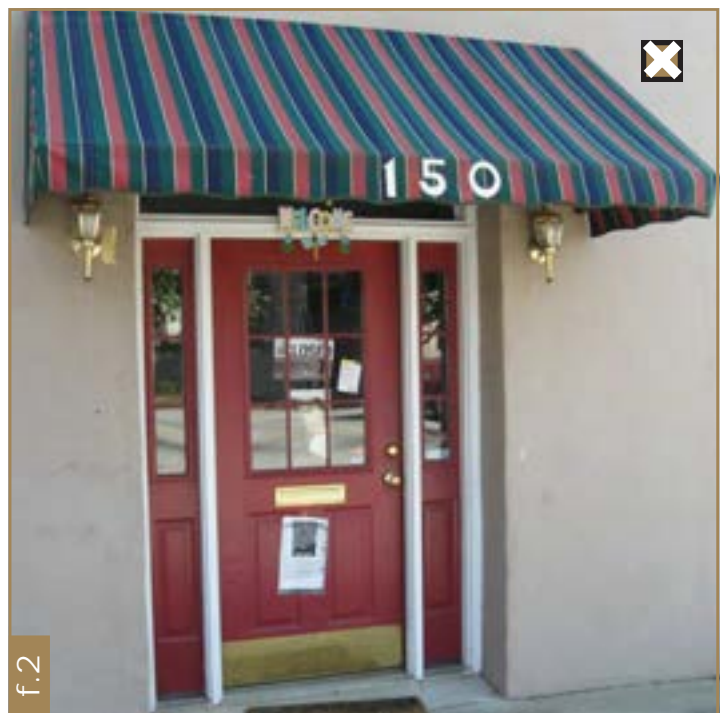
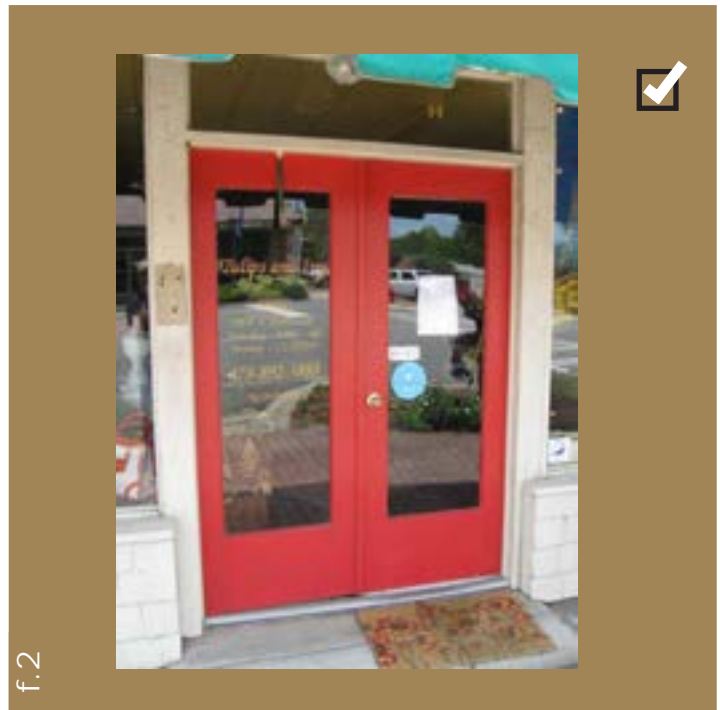
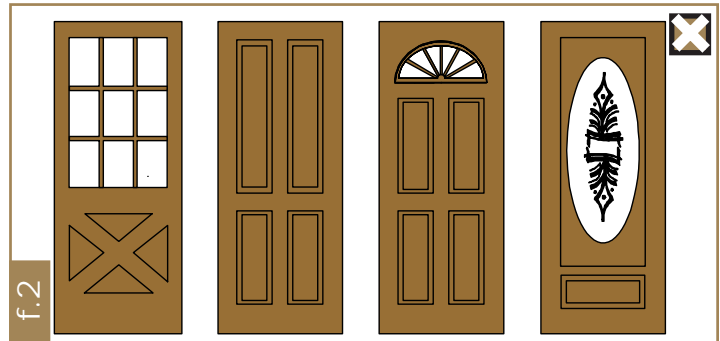

awnings & canopies

DESIGN PRESERVATION

Early wooden porch-like sidewalk covering gave way to cloth awnings in Hawkinsville. Generally retractable, they were shed type, i.e. triangular when viewed from the end. This design can be replicated by today's awnings. Flat canopies were also used and continue to be appropriate for some twentieth century buildings. Front balconies are not traditional for Hawkinsville.



MATERIALS PRESERVATION

Few if any canvas awnings remain. Historic flat canopies require regular maintenance of their paint, guttering, and turnbuckles.

GUIDELINES

- a. Maintain historic awnings and canopies.
- b. Use traditional awning materials. Fabric is the most appropriate choice for awnings.
- c. Match size and shape of awnings to the size and shape of the window or door opening.
- d. Fit an awning within the frame of the window or doorway without covering architectural details.
- e. Traditional shed-style, sloping, fabric/canvas awnings should be used.
- f. Flat metal canopies are also appropriate, though more so on twentieth century buildings than on earlier buildings.
- g. Balconies and porches should not be added to the fronts of buildings which never had them.
- h. Internally lit awnings are not appropriate. See p. 39 for lighting guidelines.

awnings & canopies

Specifics & Illustrated Examples

- b.1 Awnings should not use inappropriate materials, such as wooden shingles or rigid plastic.
- c.1 Awnings should not be shaped differently than the openings where they are used.
- d.1 Awnings should not cover architectural details such as door surrounds or decorative brick work.
- d.2 Awnings should fit within the openings and avoid covering architectural details such as cornices.
- d.3 Awnings should not continue across two storefronts to join them as one business.

 = satisfactory  = unsatisfactory

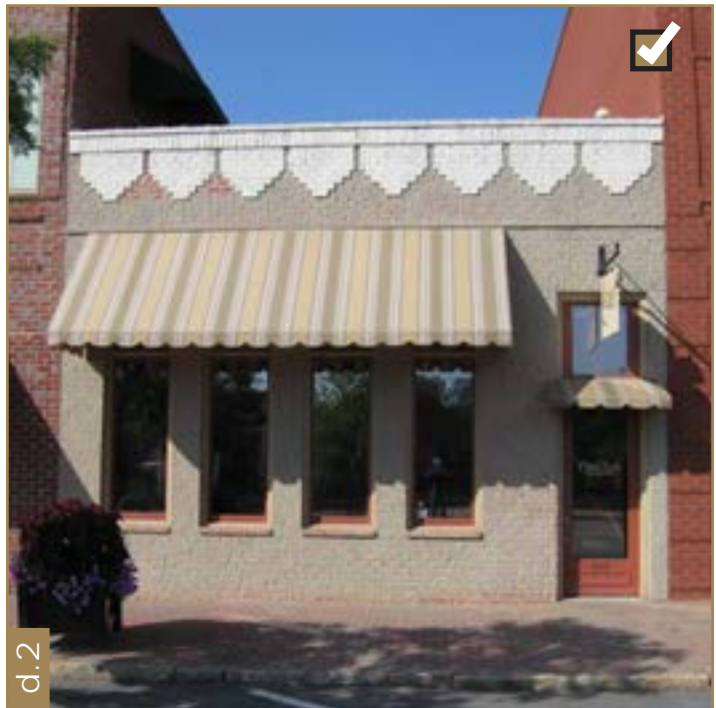
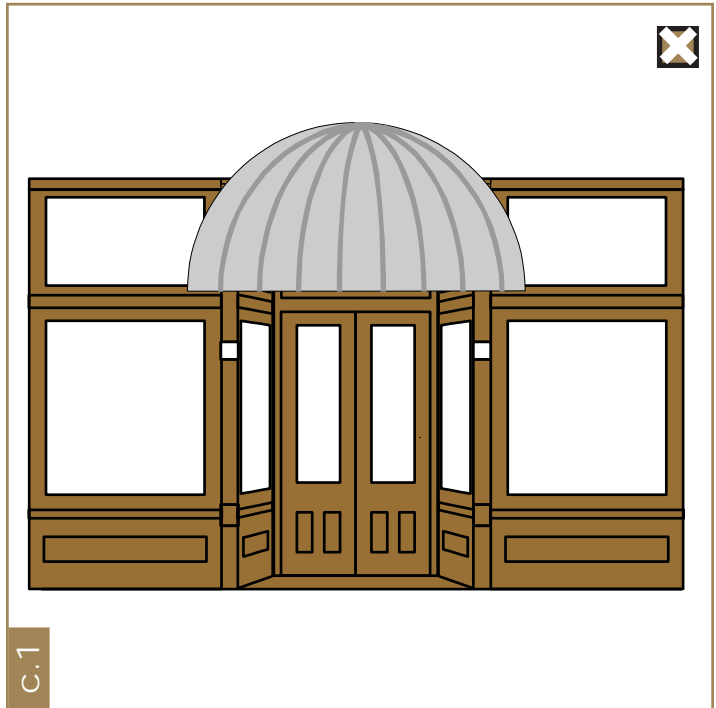

additions to historic buildings

DESIGN PRESERVATION

Built to zero lot line in the front and party walls on the sides, historic downtown buildings can only go back or up for additional space. To preserve the form of the building the building height must not change as viewed from the front. Rear additions need to be delineated from the original portion.



MATERIALS PRESERVATION

As much historic material should remain in place when adding to a building - walls, window and door openings, windows and doors, ornament, etc. This allows for possible restoration in the future and is known as “reversibility.”

GUIDELINES

- a. Additions should maintain the scale and proportions and not overwhelm the original building.
- b. An addition should have a perceivable juncture where it adjoins the historic building.
- c. Additions should not alter the orientation of historic buildings.
- d. Substantial additions should utilize materials closely matching the original material of the building.
- e. Ornamentation of new additions should use a degree of ornamentation equal to or less than the original structure.
- f. Additions should have a similar pattern of openings found on the original building.
- g. Rooftop additions should be set to the rear and not visible from the front. Rooftop additions should be avoided on corner properties.

additions to historic buildings

Specifics & Illustrated Examples

b.1 Insert a visible separation such as a small inset between where the addition meets the existing building or offsetting the new wall from the existing wall.

f.1 Windows in an addition should continue the pattern of openings while varying slightly from the historic building.

g.1 Rooftop additions should not be visible from the front.

☑ = satisfactory

☒ = unsatisfactory

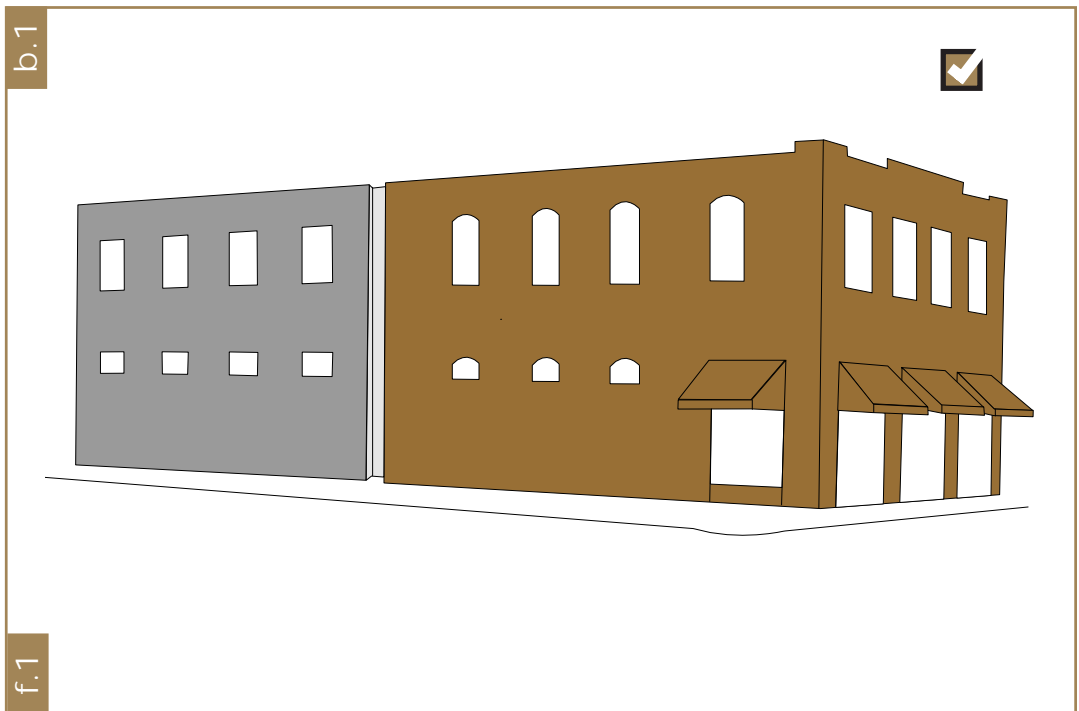
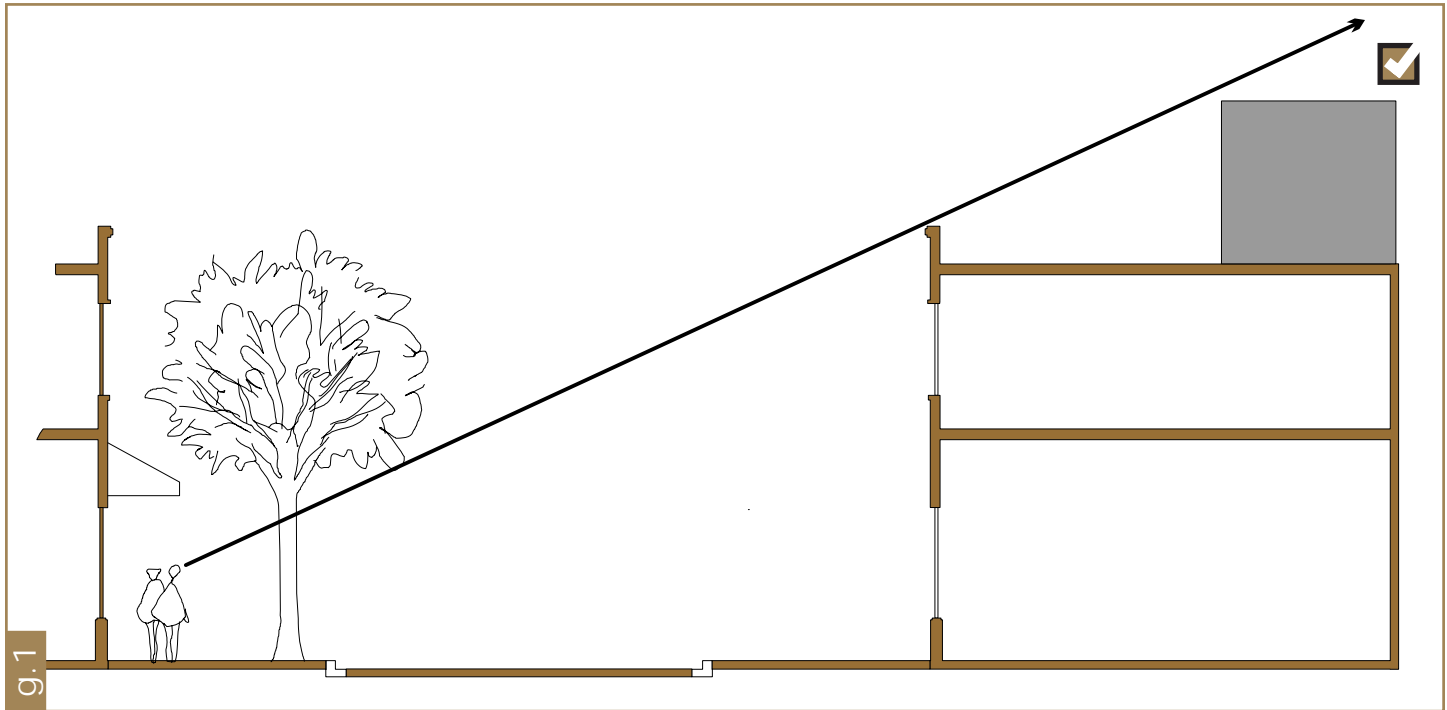



walls & fences

DESIGN PRESERVATION

Historically enclosures downtown were utilitarian – fencing storage, empty lots, even animals. Utilitarian design and materials for enclosures remain a good choice for this type of use in less visible areas. Today enclosures are also used to screen modern intrusions into the district such as parking. These should be compatible with the streetscape to best serve their purpose.



GUIDELINES

- a. Security fences should be located at the rear of buildings or similar low visibility areas. Where visible, screen with vegetation.
- b. Privacy fences are best located toward the rear of buildings or similar low visibility areas. Screening with vegetation is encouraged.
- c. Privacy fences should be constructed of wood, limited in height, and meet zoning/building codes.
- d. Screening enclosures to the front of buildings should use materials and design that reflect the surrounding buildings.
- e. Screening enclosures to the front of buildings should continue the facade line of surrounding buildings.
- f. Screening enclosures at the rear of buildings should be of simple design and use traditional materials.

fences & walls

Specifics & Illustrated Examples

- a.1 Screening vegetation should be evergreen.
- b.1 Privacy fences should not be installed flush with building facades.
- c.1 Privacy fences should not be vinyl.
- d.1 Fences with a residential design, such as wooden pickets, are not appropriate for screening in downtown.
- d.2 Screening elements continuing the facade line should be partially or wholly of masonry.

 = satisfactory  = unsatisfactory

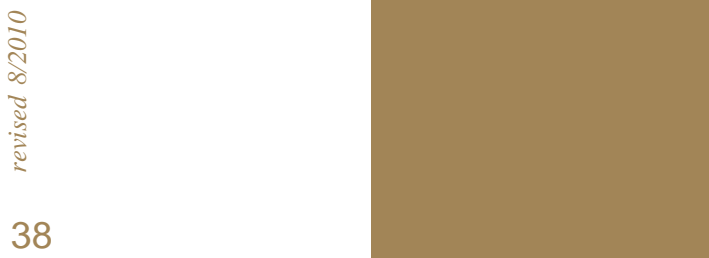

modern features

DESIGN PRESERVATION

While the design of modern features is not something to be preserved, mitigating their impact on the historic district is. Modern elements such as dumpsters, mechanical systems, parking and the like can be integrated into the historic district through sensitive placement and screening.



GUIDELINES

- a. Place modern features to the rear of the building and screen when in public view.
- b. Rooftop mechanical systems, utility meters and security lighting should be placed unobtrusively.
- c. Place code required access and egress sensitively. Fire escapes are best placed at the rear of buildings. Barrier free access should balance the needs of users with preserving the character of the building.
- d. New lighting should use traditional designs appropriate to the character of the building.
- e. Parking should be placed as unobtrusively as possible and screened.

modern features

Specifics & Illustrated Examples

- a.1 Screen HVAC when within public view. See page 35 for guidelines on fences.
- b.1 Roof top mechanicals should be placed near the rear where they are not visible from the street.
- d.1 Traditionally, downtown buildings rarely used exterior lighting at the front.
- d.2 Lighting with a utilitarian design is a good choice for rear elevations.
- e.1 Parking is best placed at the rear of the building.
- e.2 Parking to the side of a building should be screened from view

 = satisfactory  = unsatisfactory

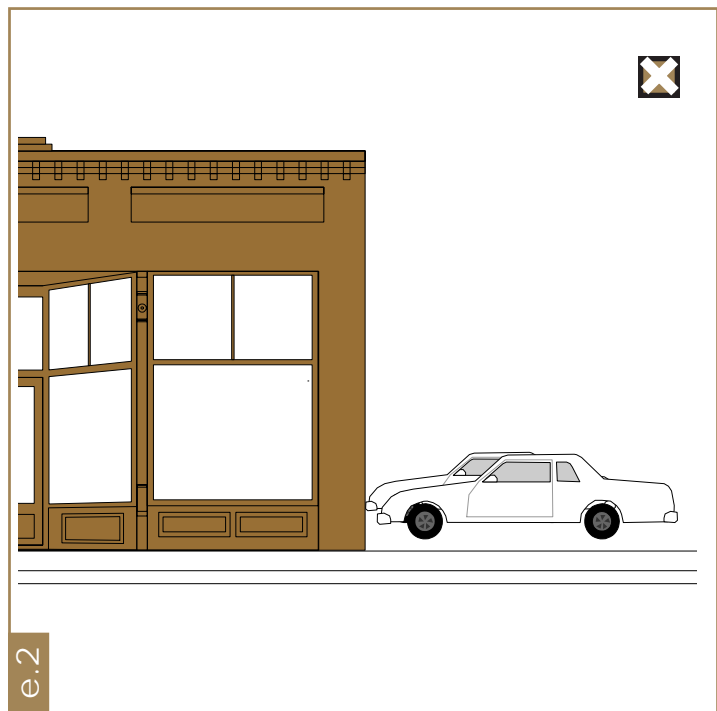
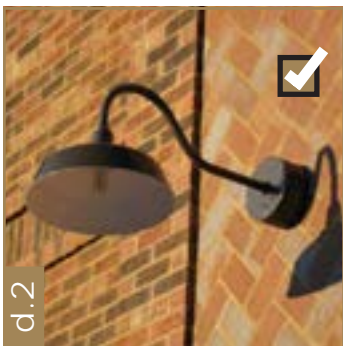
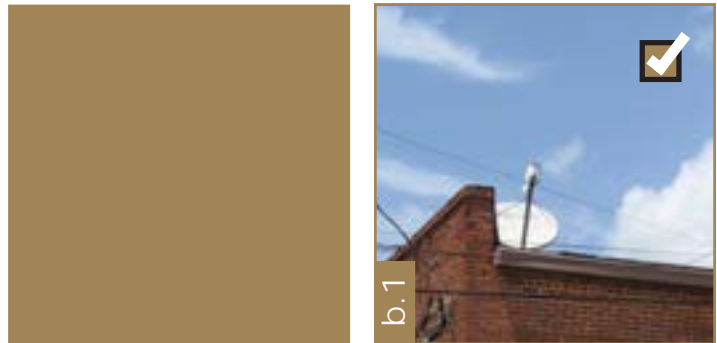
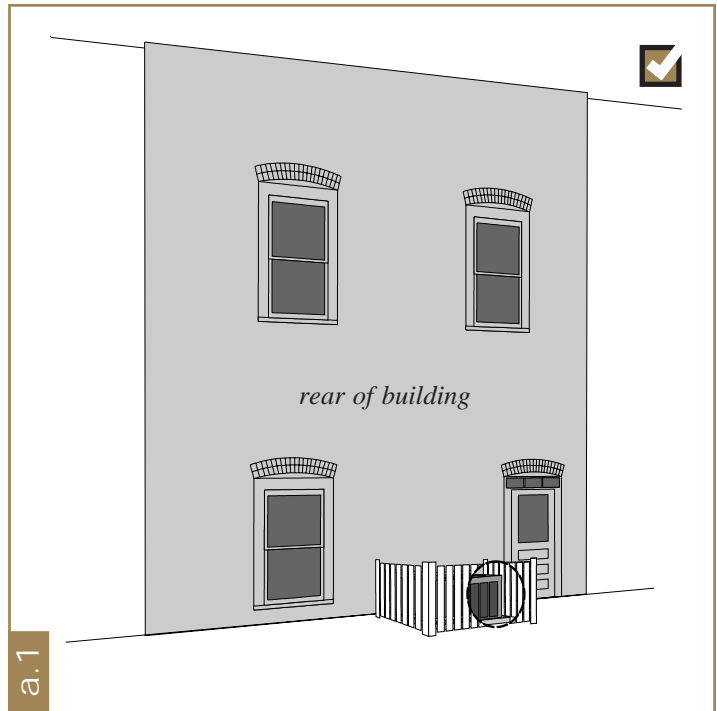

signs

DESIGN PRESERVATION

Merchants downtown have always used signage to advertise their stores and goods. While sometimes exuberant, signs downtown historically were gaged toward pedestrians and slow moving vehicles. Signs for buildings downtown should not adopt the scale and illumination of highway commercial entities.



GUIDELINES

- a. Maintain historic signs.
- b. Locate signs in traditional locations. Do not cover storefront details or exterior ornament.
- c. Use signs of painted wood, metal, or a close facsimile.
- d. Use external, unobtrusive fixtures with limited light pools for illumination. No internally lit signs.
- e. Mount signs in such a manner as to minimize the impact on the building's exterior materials.
- f. Remember: Signs must conform with Hawkinsville's Sign Ordinance (available at City Hall).

signs

Specifics & Illustrated Examples

- b.1 The sign board area above the storefront is the preferred sign location.
- b.2 Window signs are very traditional as are the valences of awnings and projecting signs.
- b.3 Do not cover details of the building with signs.
- d.1 Internally lit, box cabinet signs are not appropriate.
- d.2 Gooseneck lights or bar lights can effectively light signs.

☑ = satisfactory ☒ = unsatisfactory

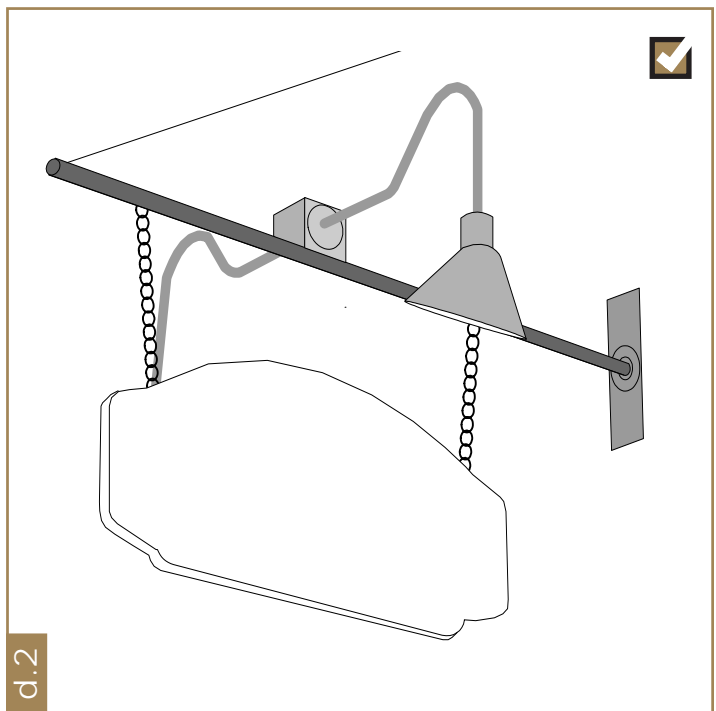
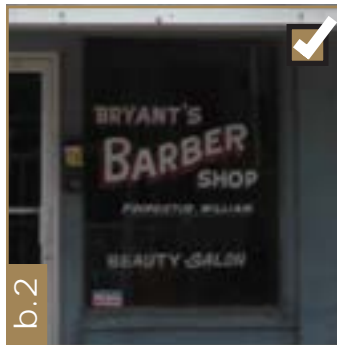

new construction guidelines



DESIGN GUIDELINES

New Construction

- 43 building placement & orientation
- 45 building scale & form
- 47 building materials & openings



building placement & orientation

DESIGN PRESERVATION

Historic downtown buildings are set at the front lot line and full width to create a continuous block. New construction should match this design. Freestanding buildings set back from the sidewalk are not appropriate. Orientation to the primary street is essential.



GUIDELINES

- a. Match the front setback of historic buildings on the block, generally at the sidewalk.
- b. Place the building centrally on the lot and generally with shared walls.
- c. Orient the building to the street. Corner buildings should orient the main entrance to the primary street.

building placement & orientation

Specifics & Illustrated Examples

- a.1 New construction should not be set back from the street, especially to provide parking.
- b.1 New construction should have shared walls and not be set back from neighboring buildings.
- c.1 New construction should not orient to off-street parking.
- c.2 New buildings on corner lots should orient to the primary street.
- c.3 Dual facades are an option for corner lots.

☑ = satisfactory ☒ = unsatisfactory

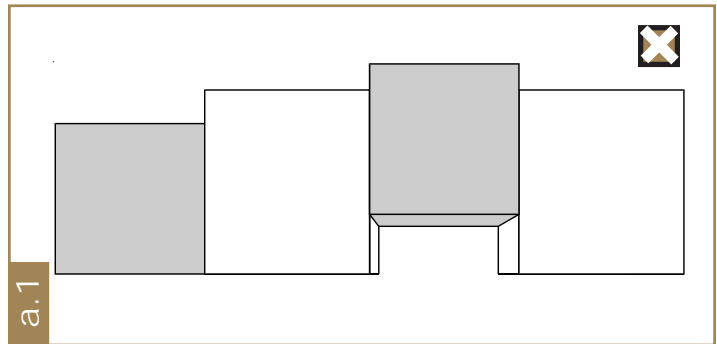

revised 8/2010

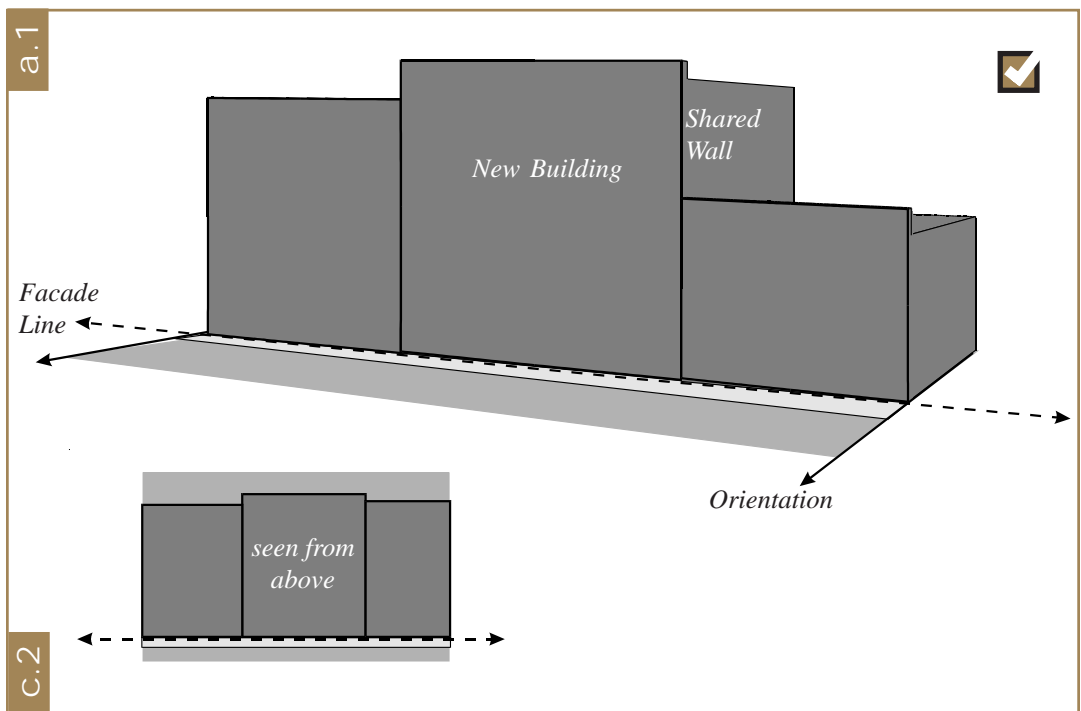

building scale & form

DESIGN PRESERVATION

Scale is a function of height and width. Height includes both the number of stories as well as the overall height. Width is both a function of actual measurement and the number of bays or vertical divisions. New construction should neither be more massive or more diminutive than historic examples.



GUIDELINES

- a. Match the general height of historic buildings.
- b. Match the story height of historic examples.
- c. Match the general overall width of historic buildings when possible.
- d. Match bay width of historic examples.
- e. Approximate the depth of historic examples for corner buildings.
- f. Use roof shapes and parapets similar to historic examples.
- g. Use walls of a single plane along street elevations.

building scale & form

Specifics & Illustrated Examples

- a.1 Avoid buildings over two stories.
- b.1 Story heights should match as well as the number of stories.
- d.1 Wide buildings should insert bays with widths based on historic examples.
- e.1 Corner lots should not cause a large break in the facade line of the secondary street with a new building of shallow depth.
- f.1 Avoid parapets with a form or style atypical of the district.
- f.2 Do not use roof forms unlike the established pattern.
- g.1 Avoid wall plane setbacks uncharacteristic of historic examples.

☑ = satisfactory ☒ = unsatisfactory

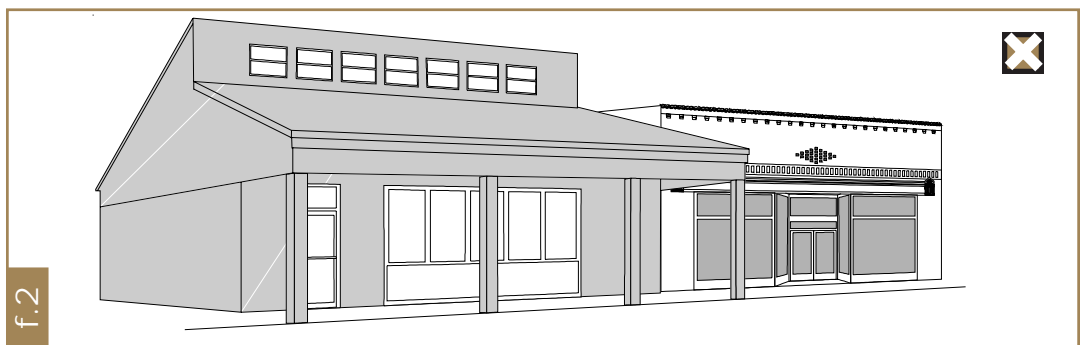
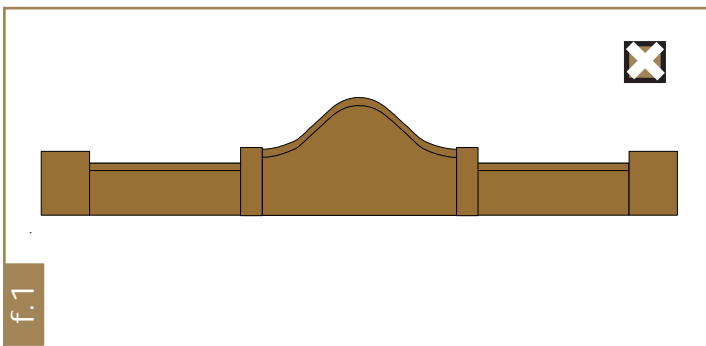
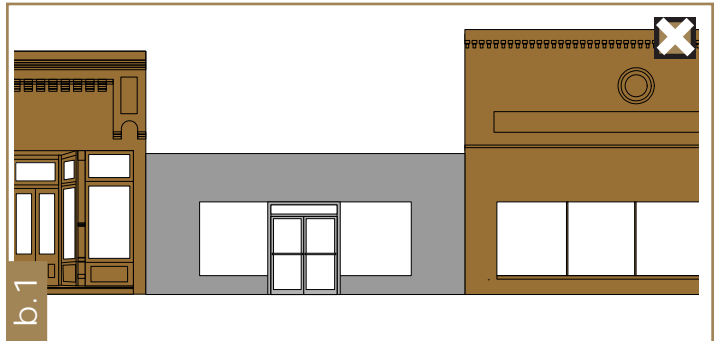

building materials & openings

DESIGN PRESERVATION

The envelope of a building creates texture. The texture of materials and details used on historic buildings should be repeated in new construction. The openings in the envelope create a second pattern. Historic downtown buildings have a very regular pattern of openings that should be repeated in new construction.



GUIDELINES

- a. Use matching or similar materials to those found on historic examples.
- b. Use ornamentation in a manner similar to that on historic examples.
- c. Use openings of similar dimensions and shape as those found on historic examples.
- d. Place and distribute openings in a manner similar to those on historic examples.
- e. Use the same ratio of wall-to-openings as found on similar locations on historic examples.

building materials & openings

Specifics & Illustrated Examples

- a.1 Using red brick with buff or gray mortar is encouraged. Painted brick is also appropriate.
- a.2 Variegated brick, synthetic stucco (E.I.F.S.), and split face CMUs are not appropriate.
- b.1 Traditional areas of ornamentation include cornices (storefront and roof line), windows, and corners.
- b.2 Simple interpretation of ornamentation on historic examples is encouraged.
- b.3 Synthetic materials may be considered for ornamentation, especially on second stories.
- d.1 Use high areas of void on ground floor fronts (storefront area) and less on second floors.
- d.2 Side elevations on corner properties may have a higher degree of uninterrupted wall space.
- e.1 Second story front windows should generally be linearly placed and evenly spaced.
- e.2 See p. 25, letter “f” for window material and design and see p. 27, letter “f” for door material and design.

 = satisfactory  = unsatisfactory

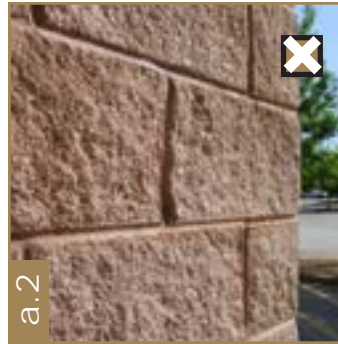

a.2



a.2

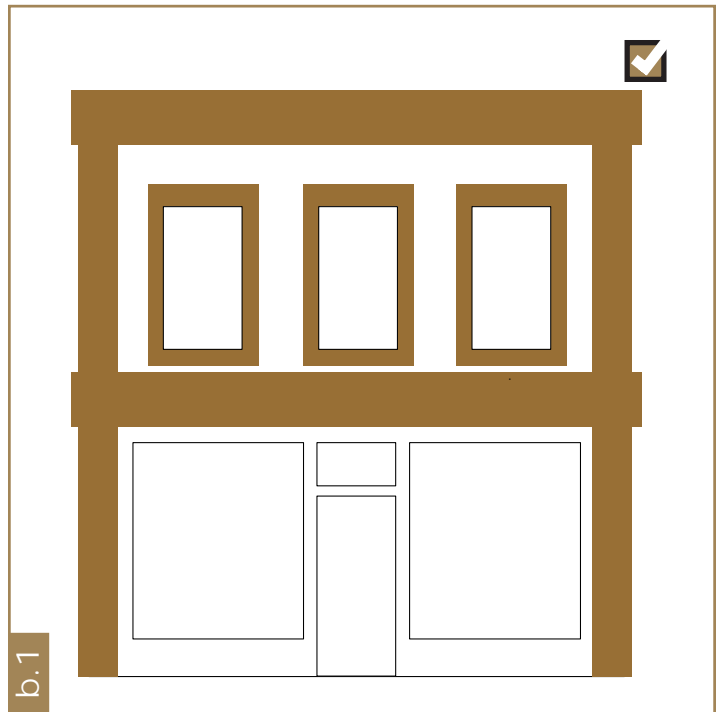

b.1

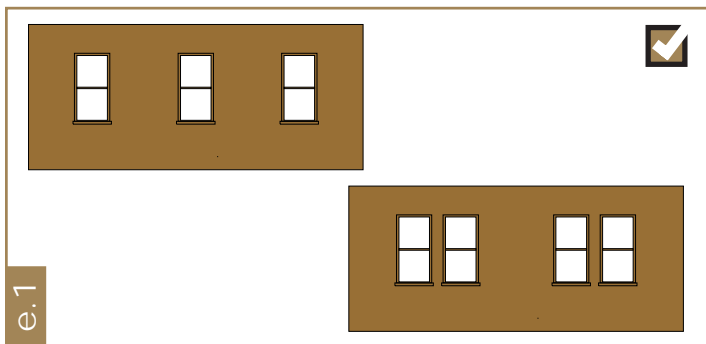

e.1

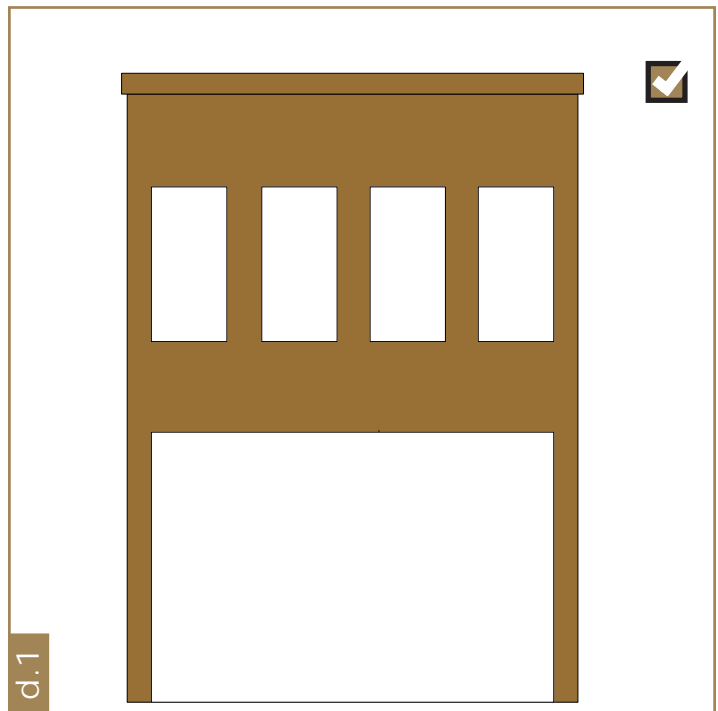

d.1

secretary of the interior's standards



SECRETARY OF THE INTERIOR'S STANDARDS

The Secretary of the Interior's Standards for Rehabilitation, developed in 1975 and revised in 1983 and 1992 by the National Park Service, present the general principles of historic preservation in a succinct and clear manner. These standards are also available in annotated and illustrated versions. The following standards are to be applied to specific rehabilitation projects in a reasonable manner, taking into consideration economic and technical feasibility.

secretary's standards

STANDARDS FOR REHABILITATION

1. A property shall be used for its historic purpose or be placed in a new use that requires minimal change to the defining characteristics of the building and its site and environment.
2. The historic character of a property shall be retained and preserved. The removal of historic materials or alteration of features and spaces that characterize a property shall be avoided.
3. Each property shall be recognized as a physical record of its time, place, and use. Changes that create a false sense of historical development, such as adding conjectural features or architectural elements from other buildings, shall not be undertaken.
4. Most properties change over time; those changes that have acquired historic significance in their own right shall be retained and preserved.
5. Distinctive features, finishes, and construction techniques or examples of craftsmanship that characterize a property shall be preserved.
6. Deteriorated historic features shall be repaired rather than replaced. Where the severity of deterioration requires replacement of a distinctive feature, the new feature shall match the old in design, color, texture, and other visual qualities and, where possible, materials. Replacement of missing features shall be substantiated by documentary, physical, or pictorial evidence.
7. Chemical or physical treatments, such as sandblasting, that cause damage to historic materials shall not be used. The surface cleaning of structures, if appropriate, shall be undertaken using the gentlest means possible.
8. Significant archeological resources affected by a project shall be protected and preserved. If such resources must be disturbed, mitigation measures shall be undertaken.
9. New additions, exterior alterations, or related new construction shall not destroy historic materials that characterize the property. The new work shall be differentiated from the old and shall be compatible with the massing, size, scale, and architectural features to protect the historic integrity of the property and its environment.
10. New additions and adjacent or related new construction shall be undertaken in such a manner that if removed in the future, the essential form and integrity of the historic property and its environment would be unimpaired.



For more information on the Secretary of the Interior's Standards for the Treatment of Historic Properties and accompanying guidelines visit:

<http://www.nps.gov/history/hps/tps/standguide/index.htm>

glossary



• *Addition.* New construction added to an existing building
• or structure.
•

• *Alteration.* Work which impacts any exterior architectural
• feature including construction, reconstruction, or removal
• of any building or building element.
•

• *Arch.* A curved construction which spans an opening and
• supports the weight above it.
•

• *Awning.* A sloped projection supported by a frame attached
• to the building facade or by posts anchored to the sidewalk.
•

• *Bay.* The horizontal divisions of a building, defined by
• windows, columns, pilasters, etc.
•

• *Bond.* A term used to describe the various patterns in which
• brick is laid.
•

• *Bracket.* A decorative support feature located under eaves
• or overhangs.
•

• *Bulkhead.* The panel between framing members and
• beneath the display windows in a storefront. Also known
• as a kickpanel.

Canopy. A flat projection from the building facade for the storefront and pedestrian traffic.

Capital. Topmost member of a column or pilaster.

Cast iron. Iron made in a mold.

Cast iron front. A storefront made of glass and pieces of utilitarian and decorative iron cast in easily assembled parts.

Column. A vertical, cylindrical or square supporting member, usually with a classical capital.

Coping. The capping member of a wall or parapet.

Corbeling. A series of stepped or overlapped pieces of brick or stone forming a projection from the wall surface.

Cornice. The uppermost, projecting part of an entablature, or feature resembling it.

Crenellation. A parapet with open spaces that surmounts a wall and is used for defense or decoration.

Course. A horizontal layer or row of stones or bricks in a wall.

Dentil. One of a series of small, square, tooth or block-like projections forming a molding.

Double hung window. A window having two sashes, one sliding vertically over the other.

Eave. The edge of a roof that projects beyond a wall.

E.I.F.S. Exterior insulation and finish systems are multi-component exterior wall systems which generally consist of: 1) an insulation board; 2) an adhesive and/or mechanical attachment of the insulation board to the substrate or existing wall surface; 3) a base coat reinforced with glass fiber mesh on the face of the insulation board; and 4) a finish coat which protects the entire system.

Elevation. Any of the external faces of a building.

Entablature. The horizontal group of members supported by the columns; divided into three major parts, it consists of architrave, frieze, and cornice.

Exposure. The width of the visible portion of lapped siding. Also known as the reveal.

Facade. The front elevation or “face” of a building.

Fanlight. A semicircular or semi-elliptical window with radiating muntins suggesting a fan.

Fascia. A projecting flat horizontal member or molding; forms the trim of a flat roof or a pitched roof; also part of a classical entablature.

Fenestration. The arrangement of window openings in a building.

Finial. A projecting decorative element at the top of a roof turret or gable.

Flat arch. An arch with wedge shaped stones or bricks set in a straight line. Also known as a Jack arch.

Flashing. Thin metal sheets used to make the intersections of roof planes and roof/wall junctures watertight.

Footprint. The outline of a building’s ground plan from a top view.

Foundation. The lowest exposed portion of the building wall, which supports the structure above.

Frame construction. A method of construction in which the major parts consist of wood.

French door. A door made of many glass panes, usually used in pairs and attached by hinges to the sides of the opening in which it stands.

Frieze. The middle horizontal member of a classical entablature, above the architrave and below the cornice.

Gable. The triangular upper portion of a wall to carry a pitched roof.

glossary

Gable roof. A pitched roof with one downward slope on either side of a central, horizontal ridge.

Ghosts. Outlines or profiles of missing buildings, details, elements, historic signs, etc.

Grilles. Flat elements of wood or plastic attached to the exterior of windows or sandwiched between panes to simulate a divided light sash, though generally without successfully replicating the look of historic windows. See also TDLs and SDLs.

Header. A brick laid with its end toward the face of the wall.

Hood molding. A projecting molding above an arch, doorway, or window, originally designed to direct water away from the opening; also called a drip mold.

Infill. New construction where there had been an opening before. Also applies to a new structure such as a new building between two older structures or new material such as block infill in an original window opening.

Jack arch. see Flat arch

Jamb. The vertical side of a doorway or window.

Keystone. The top or center member of an arch.

Light. A single pane of glass.

Lintel. A horizontal beam over a door or window which carries the weight of the wall above; usually made of stone or wood.

Masonry. Brick, block, or stone which is secured with mortar.

Massing. A term used to define the overall volume or size of a building.

Modillion. A horizontal bracket, often in the form of a plain block, ornamenting, or sometimes supporting, the underside of a cornice.

Mortar. A mixture of sand, lime, cement, and water used as a binding agent in masonry construction.

Mullion. A heavy vertical divider between windows or doors.

Muntin. A secondary framing member to divide and hold the panes of glass in a window.

National Register of Historic Places. The nation's official list of buildings, sites, and districts which are important in our history or culture. Created by Congress in 1966 and administered by the states.

Parapet. A low protective wall located at the edge of a roof.

Pediment. A triangular crowning element forming the gable of a roof; any similar triangular element used over windows, doors, etc.

Pier. A vertical structural element, square or rectangular in cross section.

Pilaster. A pier or pillar attached to a wall, often with capital and base.

Pitch. A term which refers to the steepness of roof slope.

Pointing. The process of removing deteriorated mortar from the joints of a masonry wall and replacing it with new mortar (also known as repointing or, somewhat inaccurately, tuck pointing).

Portico. A roofed space, open or partly enclosed, forming the entrance and centerpiece of the facade of a building, often with columns and a pediment.

Portland cement. A strong, inflexible (too much so for some historic buildings) hydraulic cement used to bind mortar.

Preservation. The act of maintaining the form and character of a building as it presently exists.

Quoins. Decorative blocks of stone or wood used on the corners of buildings.

Rafter. A wooden member of a roof frame which slopes downward from the ridge line.

Recessed panel. A decorative element that often functions as an area for signage.

Reconstruction. The accurate recreation of a vanished, or irreplaceably damaged structure, or part thereof.

Repointing. Raking out deteriorated masonry joints and filling them with a surface mortar to repair the joint.

Rustication. A term applied to masonry in which the edges of the joints are chamfered or recessed.

Sash. The portion of a window that holds the glass and which moves.

Sandblasting. An abrasive cleaning method where high-powered jets of sand are directed against a surface, often causing the loss of the protective fireskin of bricks.

Scale. A term used to define the proportions of a building in relation to its surroundings.

SDLs. “Simulated Divided Lights” refers to window sashes which have simulated muntins on the interior and exterior of single panes of glass. Though constructed differently, they nonetheless replicate the appearance of historic windows. See also TDLs and grilles.

Setback. A term used to define the distance a building is located from a street or sidewalk.

Shed roof. A gently-pitched, almost flat roof with only one slope.

Sidelight. A glass window pane located at the side of a main entrance way.

Siding. The exterior wall covering or sheathing of a structure.

Sill. The horizontal member located at the top of a foundation supporting the structure above. Also the horizontal member at the bottom of a window or door.

Spall. To split off from the surface, as brick that is bearing undue pressure near its face or is acted on by weathering.

Storefront. The street-level facade of a commercial building, usually having display windows.

Stretcher. A brick laid with the long side exposed, as opposed to a header.

Streetscape. The combination of building facades, sidewalks, street furniture, etc., that define the street.

Structural Glass. Used predominately for wall surfacing, these now familiar products included glass building blocks, reinforced plate glass, and pigmented structural glass. Pigmented structural glass, popularly known under such trade names as Carrara Glass, Sani Onyx (or Rox), and Vitrolite.

Stucco. Any kind of plasterwork, but usually an outside covering of portland cement, lime, and sand mixture with water.

Surround. An encircling border or decorative frame, usually around a window or door.

Terra Cotta. A fine-grained clay product used ornamentally to create architectural details on the exterior of buildings.

Transom. A small operable or fixed window located above a window or door.

TDLs. “True Divided Lights” refers to window sashes which have muntins that hold separate panes of glass. Historic windows are constructed in this manner. See also SDLs and grilles.

Veranda. A covered porch or balcony on a building’s exterior.

Wrought iron. Decorative iron that is hammered or forged into shape by hand.

reference works



BOOKS

- Blumenson, John J.G. *Identifying American Architecture: A Pictorial Guide to Styles and Terms, 1600-1945*. Nashville: American Association for State and Local History, 1977.
- Burden, Ernest. *Illustrated Dictionary of Architecture*. New York: McGraw-Hill, 2002.
- *Caring For Your Historic House*. Heritage Preservation and National Park Service. New York: Harry N. Abrams, Inc., 1998.
- Foley, Mary Mix. *The American House*. New York: Harper and Row, 1980.
- *Georgia's Living Places: Historic Houses in Their Landscaped Settings*. Historic Preservation Division, Georgia Department of Natural Resources, 1991.
- Gottfried, Herbert, and Jan Jennings. *American Vernacular Design, 1870-1940*. New York: Van Nostrand Reinhold Co., 1985.
- Jackson, J. B., *Discovering the Vernacular Landscape*. New Haven: Yale University Press, 1984.
- McAlester, Virginia, and Lee McAlester. *A Field Guide to American Houses*. New York: Alfred A Knopf, 1991.

reference works

PRESERVATION BRIEFS

The first *Preservation Brief* was published by the National Park Service in 1975. Since then, over 40 more have been added to the series. Below are the most pertinent for historic district review. The *Briefs* are available on line at: <http://www.nps.gov/history/hps/tps/briefs/presbhom.htm>. Printed copies can be ordered by calling 866-512-1800.

- #1 - Assessing Cleaning and Water-Repellent Treatments for Historic Masonry Buildings
- #2 - Repointing Mortar Joints in Historic Masonry Buildings
- #3 - Conserving Energy in Historic Buildings
- #4 - Roofing for Historic Buildings
- #6 - Dangers of Abrasive Cleaning to Historic Buildings
- #7 - The Preservation of Historic Glazed Architectural Terra-Cotta
- #8 - Aluminum & Vinyl Siding on Historic Buildings
- #9 - The Repair of Historic Wooden Windows
- #10 - Exterior Paint Problems on Historic Woodwork
- #11 - Rehabilitating Historic Storefronts
- #12 - The Preservation of Historic Pigmented Structural Glass
- #13 - The Repair & Thermal Upgrading of Historic Steel Windows
- #14 - New Exterior Additions to Historic Buildings: Preservation Concerns
- #15 - Preservation of Historic Concrete: Problems and General Approaches
- #16 - The Use of Substitute Materials on Historic Building Exteriors
- #17 - Architectural Character -Identifying the Visual Aspects of Historic Buildings as an Aid to Preserving Their Character
- #18 - Rehabilitating Interiors in Historic Buildings - Identifying Character-Defining Elements
- #19 - The Repair and Replacement of Historic Wooden Shingle Roofs
- #20 - The Preservation of Historic Barns
- #21 - Repairing Historic Flat Plaster — Walls and Ceilings
- #22 - The Preservation and Repair of Historic Stucco
- #23 - Preserving Historic Ornamental Plaster
- #24 - Heating, Ventilating, and Cooling Historic Buildings
- #25 - The Preservation of Historic Signs
- #26 - The Preservation and Repair of Historic Log Buildings
- #27 - The Maintenance and Repair of Architectural Cast Iron
- #28 - Painting Historic Interiors
- #29 - The Repair, Replacement, and Maintenance of Historic Slate Roofs
- #30 - The Preservation and Repair of Historic Clay Tile Roofs
- #31 - Mothballing Historic Buildings
- #32 - Making Historic Properties Accessible
- #33 - The Preservation and Repair of Historic Stained and Leaded Glass
- #34 - Applied Decoration for Historic Interiors: Preserving Composition Ornament
- #35 - Understanding Old Buildings: The Process of Architectural Investigation
- #36 - Protecting Cultural Landscapes: Planning, Treatment and Management of Historic Landscapes
- #37 - Appropriate Methods of Reducing Lead-Paint Hazards in Historic Housing
- #38 - Removing Graffiti from Historic Masonry
- #39 - Managing Moisture Problems in Historic Buildings
- #40 - Preserving Historic Ceramic Tile Floors
- #41 - The Seismic Retrofit of Historic Buildings
- #42 - The Maintenance, Repair and Replacement of Historic Cast Stone
- #43 - The Preparation and Use of Historic Structure Reports
- #44 - The Use of Awnings on Historic Buildings: Repair, Replacement and New Design
- #45 - Preserving Historic Wood Porches
- #46 - The Preservation and Reuse of Historic Gas Stations
- #47 - Maintaining the Exterior of Small and Medium Size Historic Buildings